

ensemble

Multi-Channel,
24bit/192kHz Audio Interface
for the Macintosh

User's Guide

V1.6 - April 2008



ensemble

User's Guide

Contents

Owner's Record	2
Introduction	3
Getting Started Quickly	4
1. Installing software	4
2. Hardware connections	4
Getting Started Quickly	5
3. OS X configuration	5
4. iTunes playback	5
Getting Started Quickly	6
5. DAW configuration	6
Getting Started Quickly	7
6. Recording	7
General Operation	8
Making Settings with Software Control Panels	8
Making Settings with Ensemble's Front Panel Encoder Knobs	8
Setting Sample Rate	9
Using 176.4–192 kHz Sampling Rates	9
Setting Clock Source	9
Digital I/O	9
Stand-Alone Mode	9
Ensemble Routing	9
General Operation	9
General Operation	10
Input Routing Diagram	10
General Operation	11
Output Routing Diagram	11
Maestro Control: Settings - Settings	12
Maestro Control: Settings - Settings (diagram)	13
Maestro Control: Levels - Output	14
Maestro Control: Levels - Input	14
Maestro Control: Levels - Input (diagram)	15
Maestro Control: Levels - Output (diagram)	15
Maestro Preferences	16
Navigating the Front Panel	18
Connections on the Rear Panel	19
Connecting Your Studio	20
Basic studio configuration:	20
Connecting Your Studio	21
5.1 surround configuration:	21
Configuring Audio Software Apps	22
Configuring Ensemble for use with audio software apps	22
Apple Soundtrack Pro	22
Apple Final Cut Pro	22
Configuring Audio Software Apps	23
MOTU Digital Performer	23
Steinberg Nuendo	23
Troubleshooting	24
Troubleshooting	25
Warnings & Copyrights	26
Declarations of Conformity	27

Owner's Record

The serial number is located on the rear panel of the unit. We suggest you record the serial number in the space provided below. Refer to it whenever you call an authorized Apogee Electronics repair facility or the manufacturer. Please be sure to return your completed warranty card immediately!

Ensemble Serial No. _____

Purchase Date _____

Dealer _____

Phone _____

Address _____

CAUTION:

Any changes or modifications not expressly approved by APOGEE ELECTRONICS CORPORATION could void your authority to operate this equipment under the FCC rules.

Please register this unit by filling in the included registration card, or registering online at <http://www.apogeedigital.com/support/register.php> Please read this manual – if you call for technical support, we'll assume that you have. There will be a quiz.

Introduction

Ensemble is a digitally–controlled Firewire audio interface specifically designed for Apple Macintosh computers. From mic preamps to Mac Core Audio connectivity to headphone outputs, Ensemble includes all that's necessary for a high–quality Mac–based recording system.

Ensemble includes several of Apogee's Core technologies, including:

SoftLimit

Soft Limit is an analog peak limiting circuit that instantaneously and gracefully controls transient peaks, thereby allowing an additional 4 dB of headroom. Soft Limit may be engaged on all 8 Ensemble analog inputs.

UV22HR

UV22HR is Apogee's industry standard dither algorithm for reducing the word–length of a digital audio signal from 24 to 16 bits. UV22HR is also being employed to produce dramatically improved internet and computer audio content without increased file sizes or data rates.

Apogee Sample Rate Conversion (SRC)

Ensemble's hardware sample rate conversion provides a high quality, flexible solution for working with digital audio hardware and software running at different sample rates. Ensemble's sample rate conversion may be applied to a digital input (to convert an input stream to Ensemble's sample rate) or to a digital output (to provide an output stream at a user selected sample rate different than Ensemble's rate).

Ensemble Requirements

1. Apple PowerMac 1.5GHz or higher, 512MB of RAM required, 1GB recommended
2. OS X 10.4.11 or greater must be installed, 10.5.3 or greater highly recommended
3. Apple Logic Pro 7.2.3 or 8.0 and above
4. One Firewire 400 cable

Please note:

The functionality described in this User's Guide is based on Ensemble firmware and software release version 1.3, released in February, 2007.

Getting Started Quickly



figure 1

1. Installing software

Insert the included CD in your Mac's optical drive slot, double click on the **Ensemble Software Installer** icon, and follow the onscreen directions provided by the installer program. After the installation is complete, it will be necessary to restart your Mac.

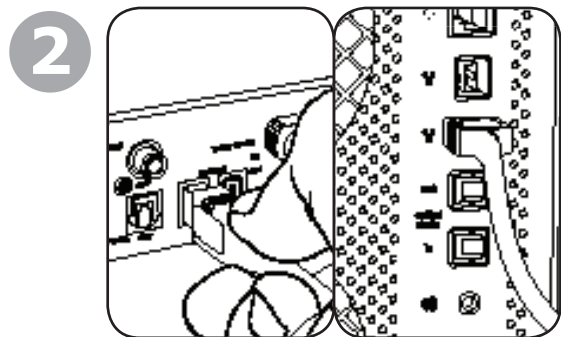

figure 2

2. Hardware connections

Using the enclosed FireWire cable, connect one of Ensemble's FireWire ports to a FireWire 400 port on your Mac (figure 2).

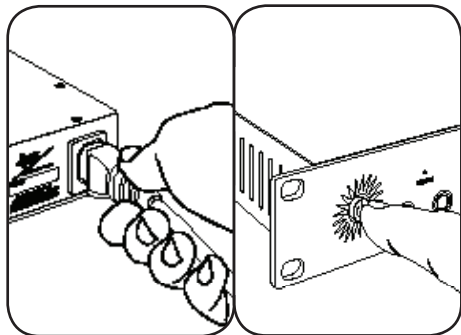

figure 3

Connect Ensemble's AC input to an AC outlet of 90 to 250 volts; Ensemble's power switch will illuminate to indicate the presence of AC. Press the power switch to turn the unit on (figure 3).

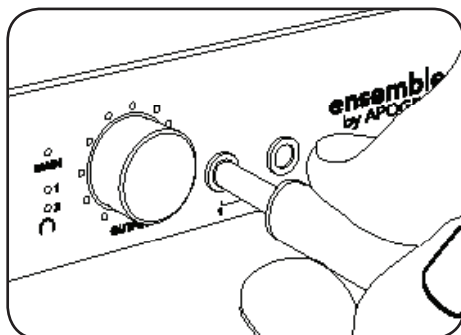



figure 4

Connect a pair of headphones to Ensemble's  1 output (figure 4).

Getting Started Quickly

3. OS X configuration

From your Mac’s Apple menu bar, open the **System Preferences** window, then click on the sound icon (figure 5).

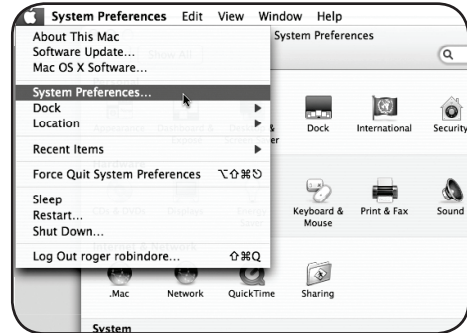

3

figure 5

In the **Sound Preferences** window click on the **Output** tab and select **Ensemble** (figure 6).

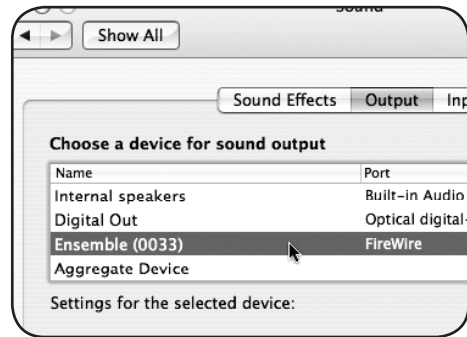
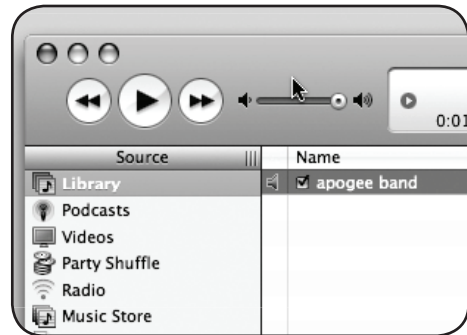

figure 6

4. iTunes playback

Open iTunes, select an audio file and initiate playback (figure 7).



4

figure 7

Press the **OUTPUT** encoder knob until the  LED is lit and adjust the level in your headphones (figure 8).

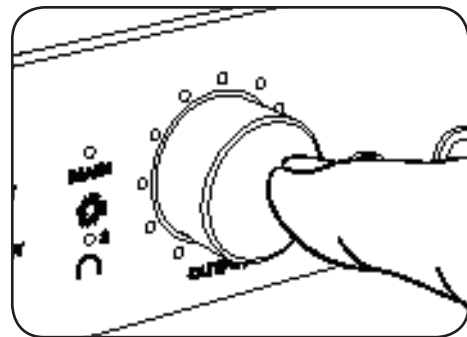

figure 8

Getting Started Quickly



figure 9

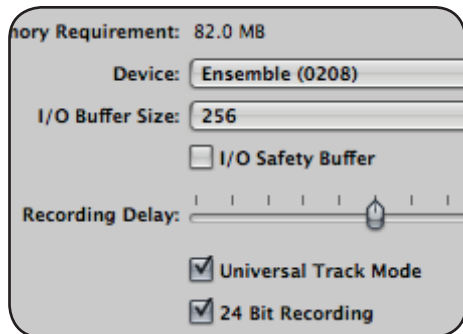

figure 10

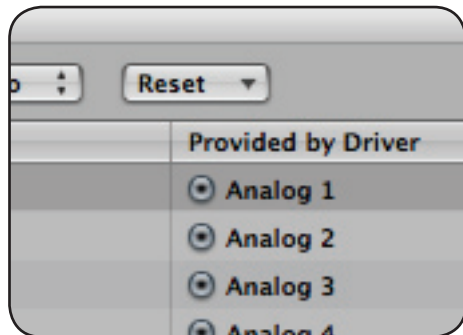

figure 11

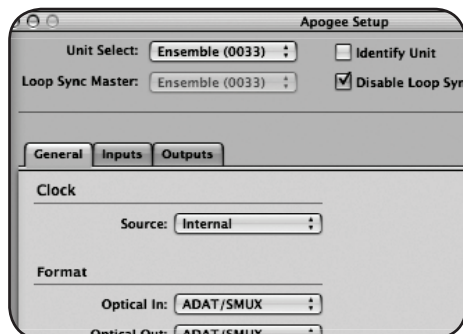

figure 12

5. DAW configuration

Configure your Core Audio compatible software to communicate with Ensemble hardware I/O.

For example, in Logic 8 Pro :

Choose **Preferences > Audio** and click on the **Devices** tab. In the **Devices** window, click on the **Core Audio** tab (figure 9).

Check the **Enabled** box, select **Ensemble** in the **Device** field, and verify that the **24 Bit Recording** box is checked. Click on **Apply Changes** when complete (figure 10).

To “customize” the I/O routing labels in Logic to match Ensemble hardware I/O, choose **Options > Audio > I/O Labels**. Click on the circle adjacent to each label under the **Provided by Driver** column (figure 11).

To control Ensemble directly from your Logic session, choose **Options > Audio > Open Apogee Control Panel** (figure 12).

If you’re using another Core Audio compatible audio software app, use Apogee’s Maestro software (installed in your **Applications** folder in Step 1) to control Ensemble.

Getting Started Quickly

6. Recording

Connect a mic to the **MIC 1** rear panel connection (figure 13).

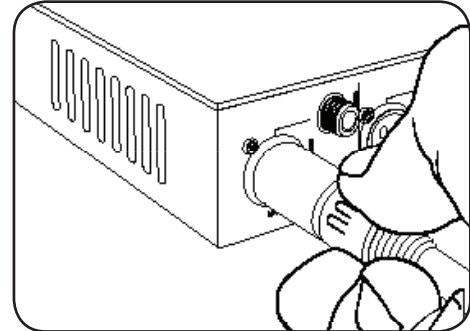

figure 13

or an instrument to the **HI-Z 1** front panel connection (figure 14).

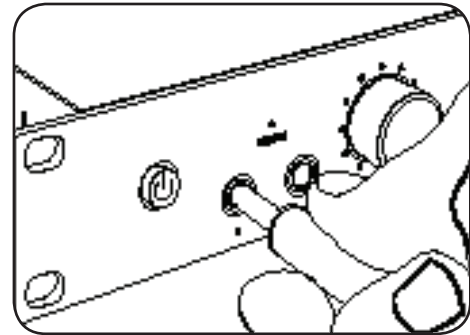

figure 14

In Logic, set a track's input to **Analog 1** and its output to **Analog 1/2** and record-enable the track (figure 15).



figure 15

Press the front panel **INPUT** encoder knob until the **Pre 1** LED is lit, and turn encoder to obtain a proper recording level on the record-enabled track (figure 16).

You're now ready to record!

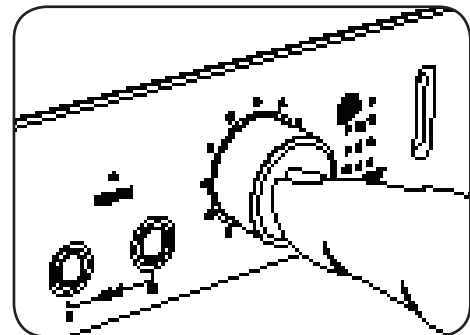

figure 16

6

General Operation



Making Settings with Software Control Panels

All Ensemble settings are made from Apogee’s Maestro **Settings** panel or Logic Pro’s **Apogee Control Panel**. Certain settings can be also be made from OS X audio control panels. It’s possible to open multiple control panels simultaneously, as settings made on one control panel are mirrored on all others. Additionally, Mic Pre gain and Output level may be controlled from Ensemble’s front panel encoders, as described on the lower half of this page.

Apogee **Maestro** provides the most complete control of Ensemble, including control of all Ensemble parameters, store/recall of configurations, expanded routing and 2 low–latency mixers. Maestro may be used with any Core Audio compatible audio application. Please see the complete explanation of Maestro’s **Settings** panel beginning on p. 14

The Logic Pro **Apogee Control Panel**, found in Logic Pro under the **Audio** menu, provides control of all Ensemble parameters and store/recall of configurations.

Audio Midi Setup (AMS) – This OS X utility (found in the rootdrive/Applications/Utilities folder) provides control of Ensemble’s clock source, sample rate and output level.

To set Ensemble’s output level using the Mac’s menu bar audio fader, set **Default Output** (in AMS) to **Ensemble**; OSX audio faders (including the menu bar fader) will then control the output selected on Ensemble’s front panel. For example, if the front panel  **1** LED is lit, OSX audio faders control the  **1** output level.



Making Settings with Ensemble’s Front Panel Encoder Knobs

Ensemble’s front panel encoders provide simple and immediate access to Mic Pre gain settings and Output levels.

To use the left encoder to control mic pre gain:

Select the mic pre gain to set by clicking the left encoder knob until the desired **PRE** LED is lit. Turn the encoder clockwise to increase gain or counter–clockwise to decrease gain. The LEDs encircling the encoder indicate its “position”, providing a quick visual indication of level in the same fashion as a traditional knob.

To use the right encoder to control output levels:

Select the output to set by clicking the left encoder knob until the desired LED is lit, and turn the knob as described above; by selecting **MAIN**, rear panel analog output levels may be set; by selecting either  **1** or  **2**, the corresponding front panel headphone output level may be set.

By pressing and holding the right encoder button for a few seconds, all analog outputs are muted. The selected output LED flashes to indicate muting.

Please see p. 16 to configure the **MAIN** and headphone outputs

General Operation

Setting Sample Rate

To set Ensemble’s sample rate, choose the desired rate in your Core Audio compatible software application; Ensemble will set itself to this rate. If the application has no sample rate setting, open the OSX utility Audio Midi Setup, select Ensemble in the **Properties For** field and select the desired rate in the **Format** field.

Using 176.4–192 kHz Sampling Rates

To operate Ensemble at a sample rate of 176.4-192k, it’s necessary to set **I/O Allocation** (found in Maestro under **Tools>Settings>Settings** tab) to either **10x10** or **8x8**. As Optical I/O is not supported at these sample rates, their associated Firewire paths are disabled to conserve CPU bandwidth.

After changing **I/O Allocation**, it’s strongly suggested to re-boot the computer and power the Ensemble off and then on.

Setting Clock Source

Ensemble’s clock source may be set from Maestro, Logic Pro’s Apogee Control Panel, or from OSX’s Audio Midi Setup utility.

When Ensemble is locked to an external source, Ensemble’s sample rate is still determined by the selection in software. Thus, the sample rate of the external source must be manually set to match the software sample rate. For example, if you want to open a session at 88.2 kHz but lock Ensemble to word clock from an Apogee Big Ben, you must manually set the Big Ben to 88.2 kHz.

Digital I/O

The availability of Ensemble’s digital I/O is based on the unit’s sample rate and **Optical I/O Format** setting, as depicted in the chart below.

	Analog I/O	Optical I/O	Coaxial I/O	Total
44k1/48k	8	8 ADAT or 2 S/PDIF	2	18
88k2/96k	8	4 SMUX or 2 S/PDIF	2	14
176k4/192k	8	none	2	10

Stand-Alone Mode

When Ensemble’s firewire connection is interrupted, the unit automatically enters Stand-Alone mode, whereby all current control panel, routing and mixer settings remain operational, despite the absence of a host computer. In Stand-Alone mode, the Status LED turns green and all front panel controls remain active.

Ensemble Routing

Unless routing is modified in Maestro software, all Ensemble rear panel inputs are routed via Firewire to the Mac, while all rear panel outputs are routed via Firewire *from* the Mac, as depicted on the next two pages.

General Operation

Input Routing Diagram

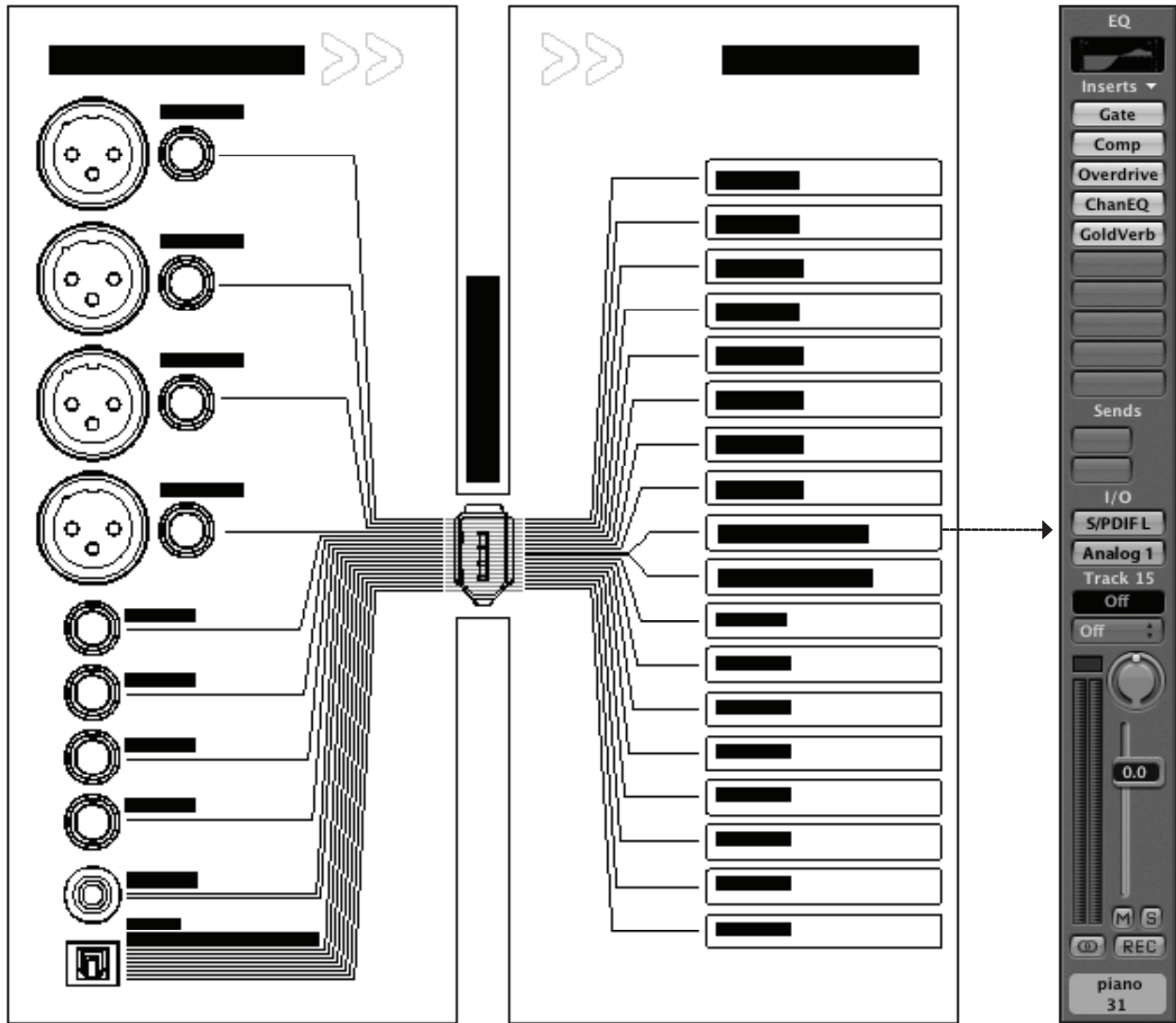

General Operation

Output Routing Diagram

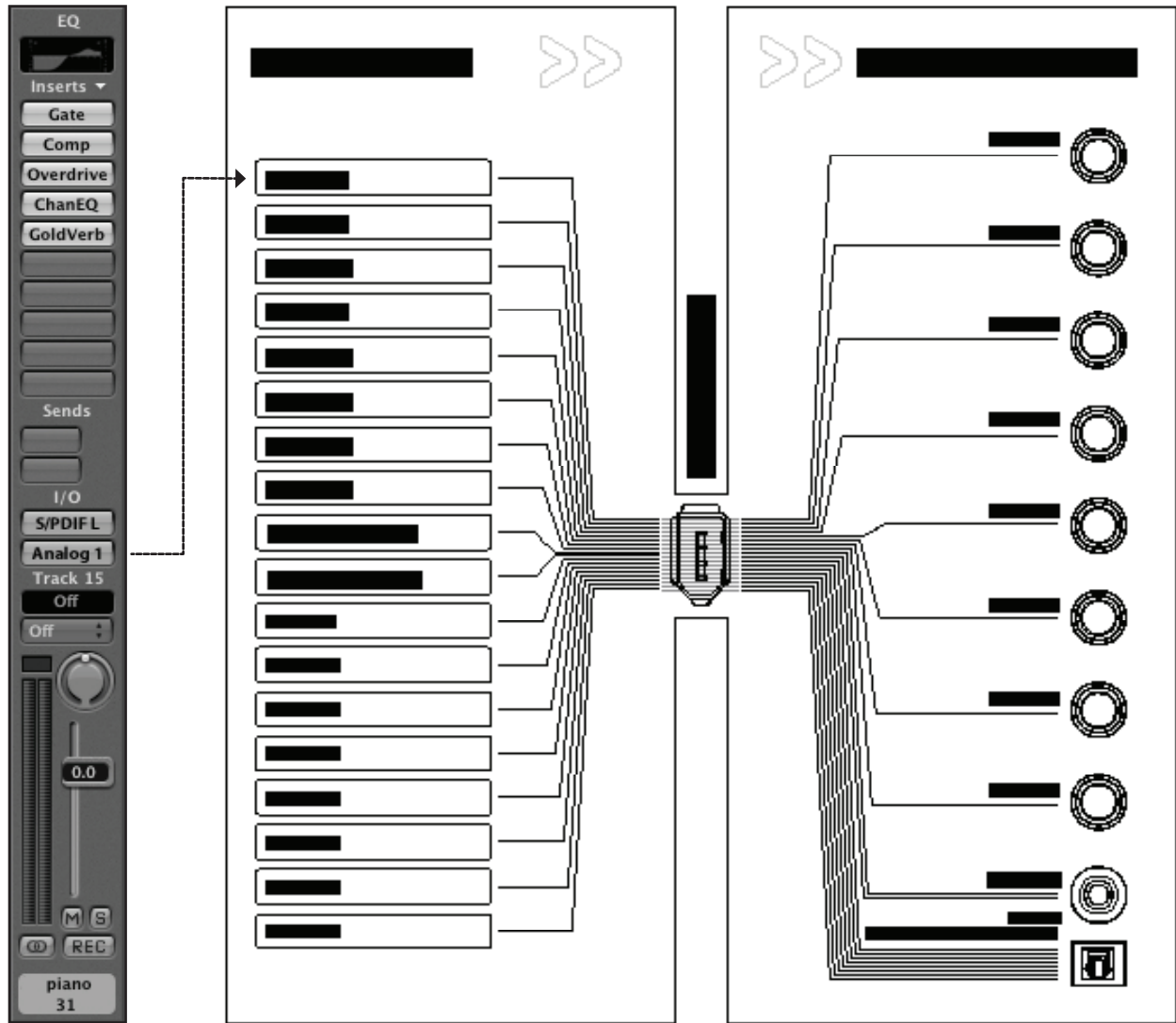

Maestro Control: Settings - Settings

All Ensemble settings are made from Apogee’s Maestro **Settings** panel or Logic Pro’s **Apogee Control Panel**. If you’re using Logic Pro, please see the description of the Apogee Control Panel in the Logic Pro documentation.

- 1 **Unit select** - When multiple Apogee devices are connected to the computer, this selection designates which device is currently being controlled by Maestro.
- 2 **Identify Unit** – When checked, all LEDs on the “active” Ensemble’s front panel light, thereby allowing easy identification of the hardware receiving software control panel settings.
- 3 **Clock Source Select** – This drop down list is used to set Ensemble’s clock source to **Internal** or to the **S/PDIF Coax**, **Optical**, or **Word Clock** rear panel inputs.
- 4 **SRC Select** – Sample rate conversion is applied to the stereo audio path selected in this drop down list. When converting a digital input (at any sample rate) to the sample rate of Ensemble (and thus the DAW session), apply sample rate conversion to the digital input.
- 5 **SRC Rate** – When converting the output of the DAW session to another sample rate, apply sample rate conversion to a digital output (under **SRC Select**) and select the desired destination sample rate in the **SRC Rate** drop down list.
- 6 **UV22HR** – UV22HR is applied to the stereo audio path selected in this drop down list. UV22HR should be applied to analog and digital inputs when recording to a 16-bit session and applied to digital outputs when routing signals from Ensemble to 16-bit digital devices such as external CD burners or DAT recorders. UV22HR is only available at sample rates of 44.1k – 48k, as higher sample rate formats and devices support 24 bit operation only.
- 7 **I/O Allocation** – With this drop down menu it’s possible to allocate the number of channels made available through Firewire I/O. When using slower host computers and/or higher sample rates, allocating fewer channels to Firewire I/O means less CPU resources are used for Firewire communication. Please note that when an 18 x 18 allocation is selected, the highest sample rate possible is 96kHz. Also, any hardware I/O may be routed through the available Firewire I/O in the Maestro Routing pages.
- 8 **Bandwidth used** – This meter measures the percentage of bandwidth used by all Firewire AUDIO devices connected to the Mac’s internal firewire bus. Bandwidth used by hard drives is not included. If the meter reads 100%, select a smaller I/O Allocation setting.
- 9 **Optical In** – This drop down list sets the digital format of the rear panel Optical In to either **S/PDIF** or **ADAT/SMUX**.
- 10 **Optical Out** – This drop down list sets the digital format of the rear panel Optical Out to either **S/PDIF** or **ADAT/SMUX**.
- 11 **Meter Display** – The signal displayed by the front panel meters may be set from this drop down list. Settings available are **Off** (meters display no signal), **Input** (meters display Ensemble inputs) or **Output** (meters display Ensemble outputs)
- 12 **Word Clock Out** – The rate of the word clock output may be set in this drop down list to be equal to the unit sample rate (WC x 1) or 1/2 the unit sample rate (WC x 1/2), to accommodate connected devices.
- 13 **CD Mode** – Checking this box sends a 44k1, 16-bit stereo signal to the S/PDIF Coax output, regardless of the DAW session sample rate or bit depth. **CD Mode** sets **UV22HR** to **S/DPIF Out**, and if the DAW session is at any other sample rate than 44k1 sets **SRC Select** to **S/PDIF Out** and **SRC Rate** to **44k1**.
- 14 **Hold Overs** – By checking this box, the red Over indicators on the front panel meters and in Maestro’s Settings/Output page remain lit until the Clear Meters button (in Maestro’s Mixer window) is clicked.
- 15 **Input Settings : Soft Limit** – When checked, Apogee’s Soft Limit overload protection is engaged on the corresponding Analog input.
- 16 **Input Settings : +4, –10, MIC** – The nominal reference level of each analog input is selected with these radio buttons. Inputs 1–4 may also be set to MIC level, allowing gain to be set from +10 to +75 dB.
- 17 **Output Settings** – The nominal reference level of each analog output is selected with these radio buttons.

Maestro Control: Settings - Settings (diagram)

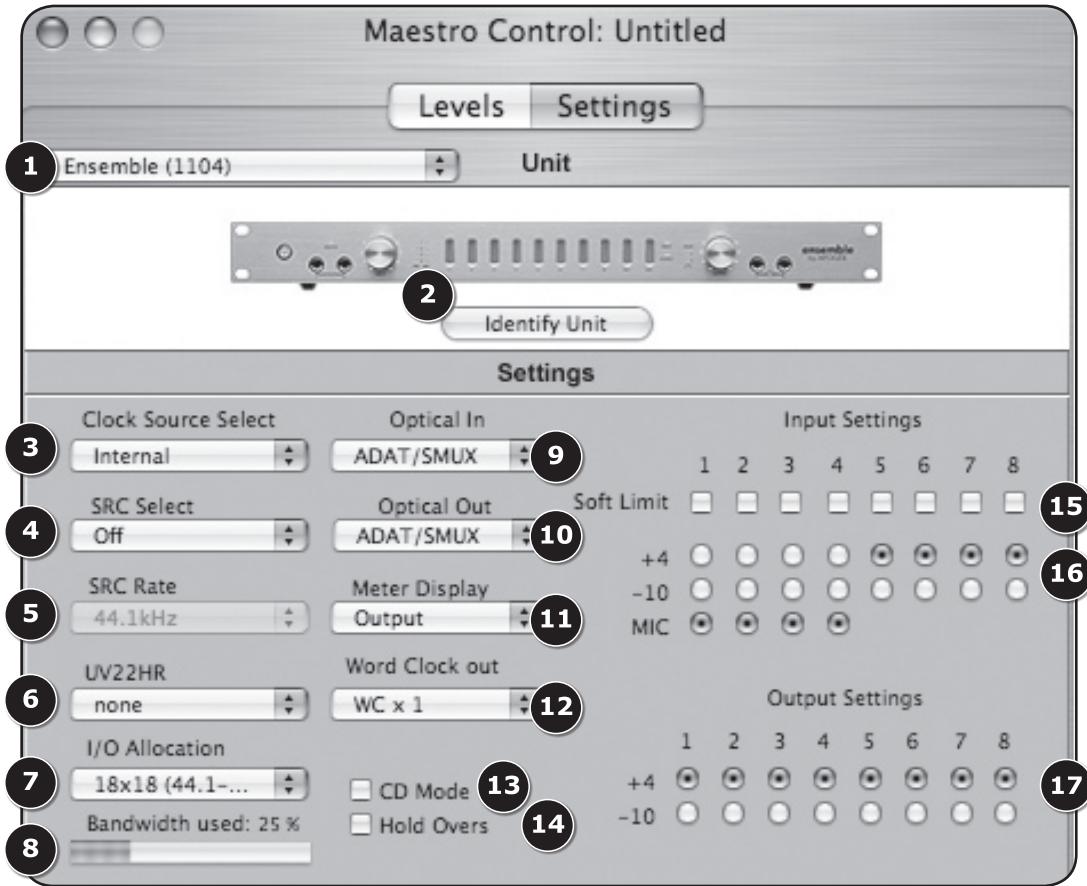

Maestro Control: Levels - Output

- 1 **Level Control** – Three knobs provide level control for the Main, HP1 and HP2 outputs. Output attenuation from 0 to –127 dB is displayed in a corresponding readout.
- 2 **Meter Display** – Signal present on any channel selected in the **MAIN Format Select** or **HP 1–2 Source Select** drop down lists is displayed on the corresponding meter.
- 3 **MAIN Format Select** – This drop down list is used to configure the analog outputs for various monitoring situations.

When **Format** is set to **None**, all Analog outputs function as standard Line outputs; the **Main** Level fader has no function.

When **Format** is set to **Stereo**, the **Main** Level fader (and front panel **Output** encoder) controls the level of Analog outputs 1–2. Outputs 3–8 function as standard Line outputs.

When **Format** is set to **5.1 Surround**, the **Main** Level fader (and front panel **Output** encoder) controls the level of Analog outputs 1–6. Outputs 7–8 function as standard Line outputs.

When **Format** is set to **7.1 Surround**, the **Main** Level fader (and front panel **Output** encoder) controls the level of all the Analog outputs.
- 4 **HP1 HP2 Source Select** – These drop down lists are used to select the stereo signal source for the front panel head-phone outputs.

Maestro Control: Levels - Input

Pre1 – Pre4 – The following controls are provided for Pre1–Pre4

- 1 **Gain Control** – This knob provides gain control for the mic pre. Mic pre gain from +10 to +75 dB is displayed in a corresponding readout.
- 2 **Meter Display** – This meter displays the conversion level of the corresponding channel, for a convenient reference when setting mic pre gain.
- 3 **Groups** – The Gain Control of two or more Pres may be linked by selecting the same Group in this drop down list. The Gain offset present when Pres are initially grouped is maintained after grouping.
- 4 **Phase** – When this box is checked, polarity of the corresponding analog input is inverted.
- 5 **48V** – When this box is checked, 48 volt phantom power is applied to the corresponding XLR input.
- 6 **SoftLimit** – When this box is checked, Soft Limit overload protection is applied to the corresponding analog input.

Maestro Control: Levels - Output (diagram)

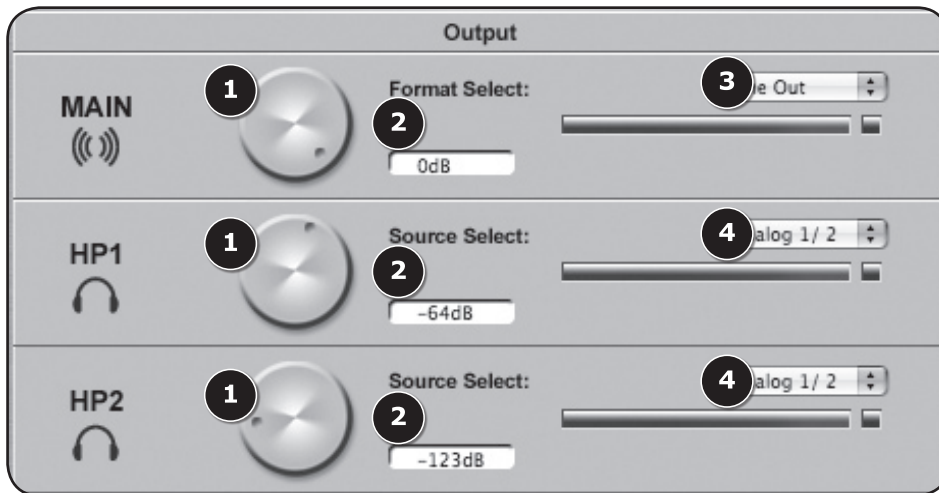

Maestro Control: Levels - Input (diagram)

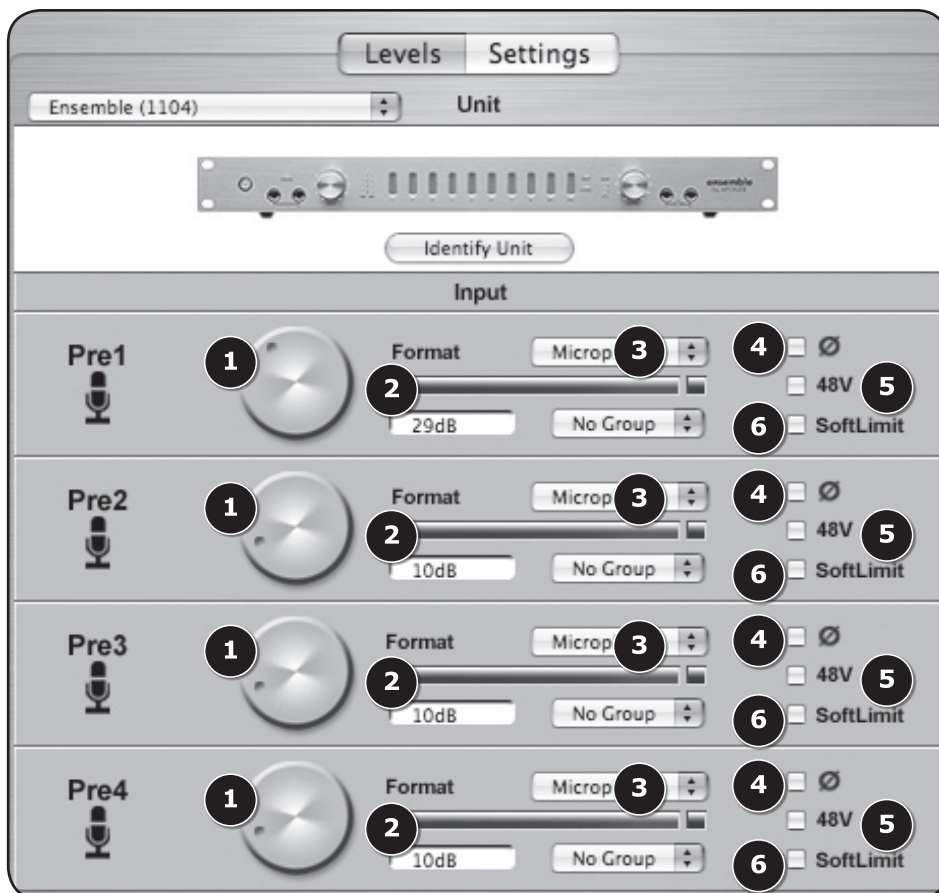

Maestro Preferences

The following Maestro preferences determine the behavior of connected hardware. Please consult the Maestro User's Guide for more information about software preferences.

Launch Maestro automatically when connecting a device

When this box is checked, Maestro is launched automatically when Ensemble is detected on the Mac's FireWire bus.

Enable pop-ups

When this box is checked, Encoder pop-ups appear on the Mac desktop when the front panel encoders are manipulated. The pop-ups display various Ensemble settings, including input and output selection, level, Input groups and Output muting. To illustrate, a few examples are shown below.



Pre1 input selected
encoder set to 38 dB

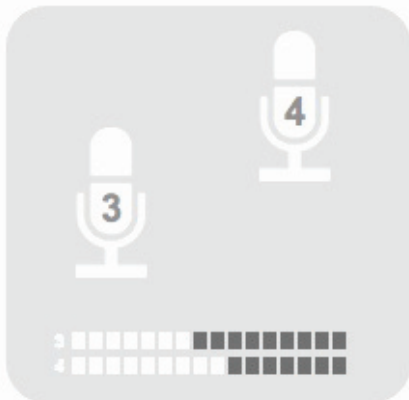

Pre3-Pre4 inputs grouped and selected
encoder 3 set to 40 dB
encoder 4 set to 50 dB

Maestro Preferences



Analog (Main) output selected
encoder set to -60 dB



HP2 output selected
encoder set to 0 dB

Navigating the Front Panel

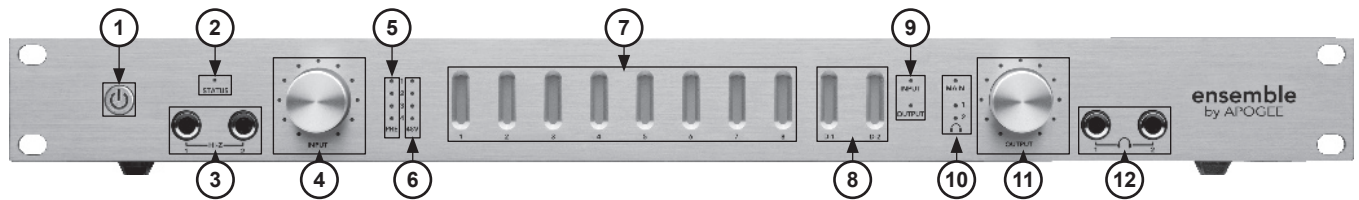

- ① **Power Switch** – Press this button to apply power to Ensemble. When Ensemble's AC input is connected, the switch will light dimly to indicate that the unit is in Standby.
- ② **STATUS LED** – This multi-color LED provides a quick visual indication of the status of various parameters.
 - A solid blue LED indicates that Ensemble is locked to the clock source chosen in software control and that the Firewire connection is valid.
 - A flashing LED indicates that Ensemble is not locked to the selected clock source.
 - A red Status LED indicates that Ensemble has not achieved a valid Firewire connection. After a few moments Ensemble will switch to Stand-Alone mode.
 - A green LED indicates that no Firewire connection is present, and that Ensemble is operating in Stand-Alone mode.
 - A flashing red LED indicates that both error conditions are present.
- ③ **HI-Z Input 1-2** – These 1/4 inch connectors accept high impedance sources such as keyboards and guitars. When a jack is inserted in a Hi-Z connector, the input's XLR connector is disabled.
- ④ **INPUT Encoder Knob** – When inputs 1-4 are set to Mic using software control, this knob controls the mic pre gain; To select the input being controlled, press the encoder knob until the desired **PRE** LED lights ; turn the encoder clockwise to increase level or counter-clockwise to decrease level. The LEDs encircling the encoder knob indicate the "position" of the knob, providing a quick visual indication of level in the same fashion as a traditional knob. If no inputs are set to Mic in software control, the encoder has no function.
- ⑤ **PRE LEDs** – These LEDs indicate the selected channel in conjunction with the **INPUT** encoder knob.
- ⑥ **48V LEDs** – These LEDs indicate that 48 volt phantom power has been engaged in software control.
- ⑦ **Meters 1-8** – These meters display either analog inputs or analog outputs, as set in software control.
- ⑧ **Meters D1,D2** – Meter **D1** displays the presence of signal on either channel of the S/PDIF Coax I/O, meter **D2** displays the presence of signal on any channel of the Optical I/O.
- ⑨ **INPUT, OUTPUT LEDs** – These LEDs indicate if meters are displaying input or output signals, as set in software control.
- ⑩ **MAIN, Phones 1,2 LEDs** – These LEDs indicate the selected output to be modified by the **OUTPUT** encoder knob.
- ⑪ **OUTPUT Encoder Knob** – This knob controls the level of the selected output as indicated by the MAIN, hp1 and hp2 LEDs. Operation is similar to that of the Input encoder knob as described above. If Main is set to None in software control, the encoder knob has no effect on the Main outputs.
- ⑫ **HP 1,2** – These TRS connectors provide headphone outputs

Connections on the Rear Panel

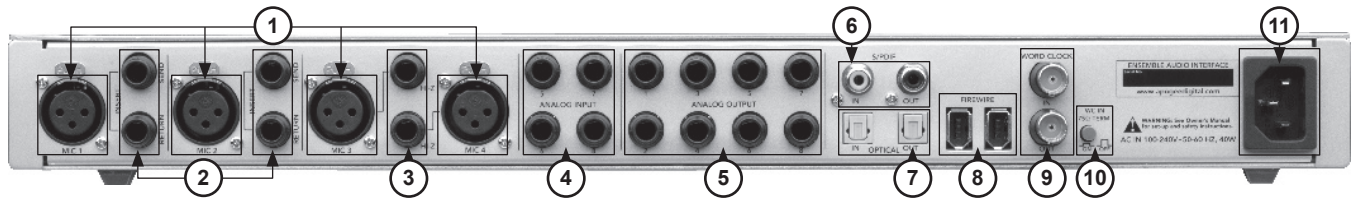

- ① **MIC1–4** – These XLR connectors accept balanced mic or line inputs; input level is determined in software control.
- ② **INSERT SEND – RETURN** (channels 1–2) – These TRS connectors provide balanced analog insert points before the A/D conversion stage; inserting a jack in the **RETURN** connector activates insert return.
 - The insert send may also serve as a direct out: when only the insert send is connected, signal to the A/D conversion stage is not interrupted.
 - The insert return may also serve as a balanced TRS line input.
- ③ **HI-Z** (channels 3–4) – These TRS connectors accept high impedance inputs for channels 3–4, similar to front panel **HI-Z** inputs.
- ④ **ANALOG INPUT 5–8** – These TRS connectors accept line level inputs for channels 5–8; input level is determined in software control.
- ⑤ **ANALOG OUTPUT 1–8** – These TRS connectors provide line level outputs for channels 1–8; input level is determined in software control.
- ⑥ **S/PDIF** – These coaxial connectors provide S/PDIF format digital I/O.
- ⑦ **OPTICAL IN/OUT** – These Toslink connectors provide S/PDIF, ADAT or SMUX format digital I/O; format is determined in software control.
- ⑧ **FIREWIRE** – These FW 400 connectors provide Firewire I/O to an Apple OSX computer.

Stand-Alone Mode – If Ensemble doesn't detect a valid Firewire connection, it will switch to Stand-Alone mode after a few moments. This is indicated either by a red STATUS LED (when the Firewire connection is present but not valid) or by a green LED (when there is no Firewire connection). In Stand-Alone mode, all routing, mixing and control settings made when the unit was last connected to a Mac are saved in Ensemble flash memory, thus allowing the use of the unit when not connected to a computer. Thus, it's possible to use Ensemble as a Stand-Alone mixer or AD-DA converter.
- ⑨ **WORD CLOCK IN/OUT** – These BNC connectors provide word clock I/O.
- ⑩ **WC IN 75 OHM TERM** – This switch terminates the Word Clock input with a 75 ohm load.
- ⑪ **AC IN** – This IEC connector accepts AC input from 90–250 volts.

Connecting Your Studio

Basic studio configuration:

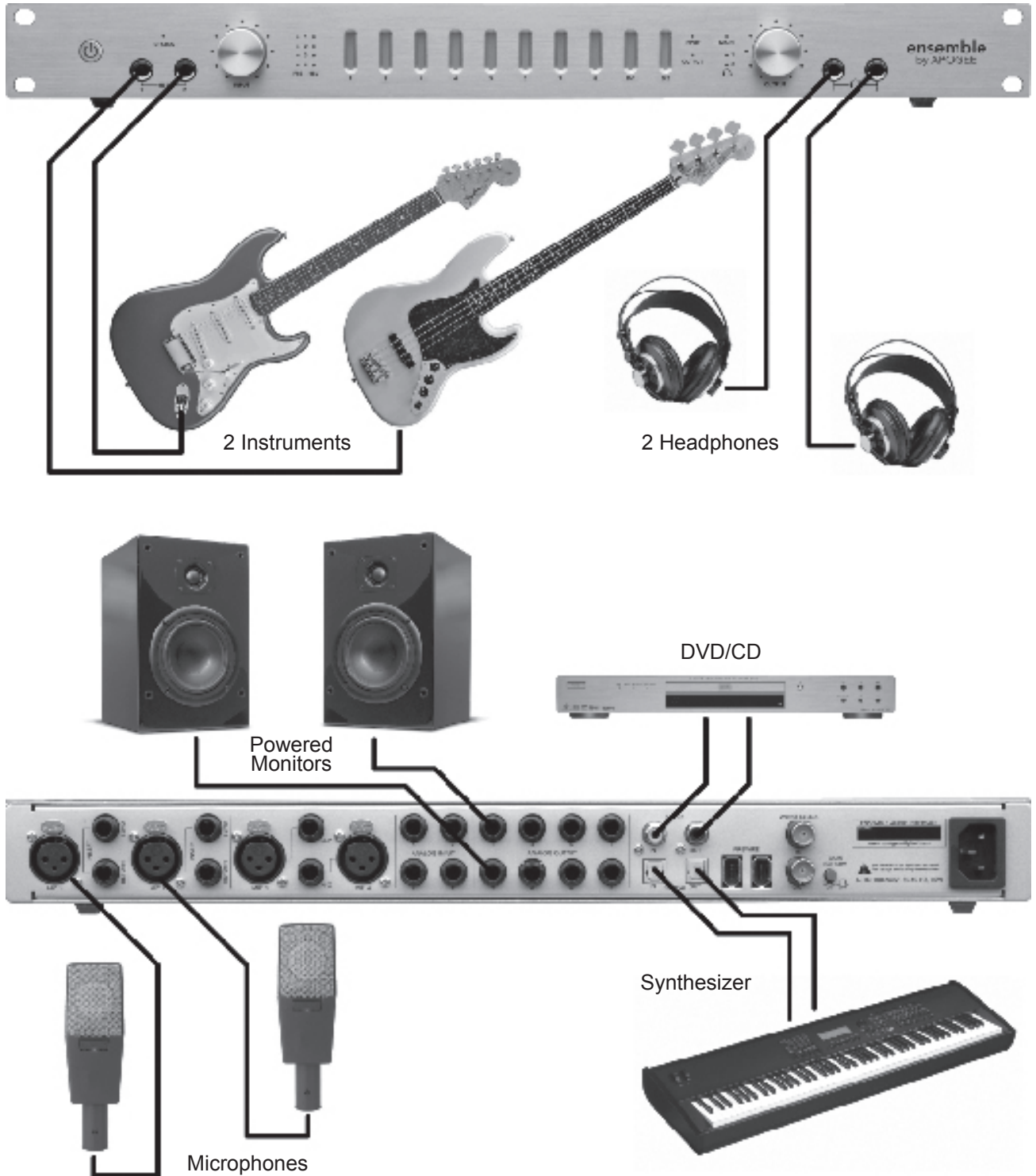

Connecting Your Studio

5.1 surround configuration:

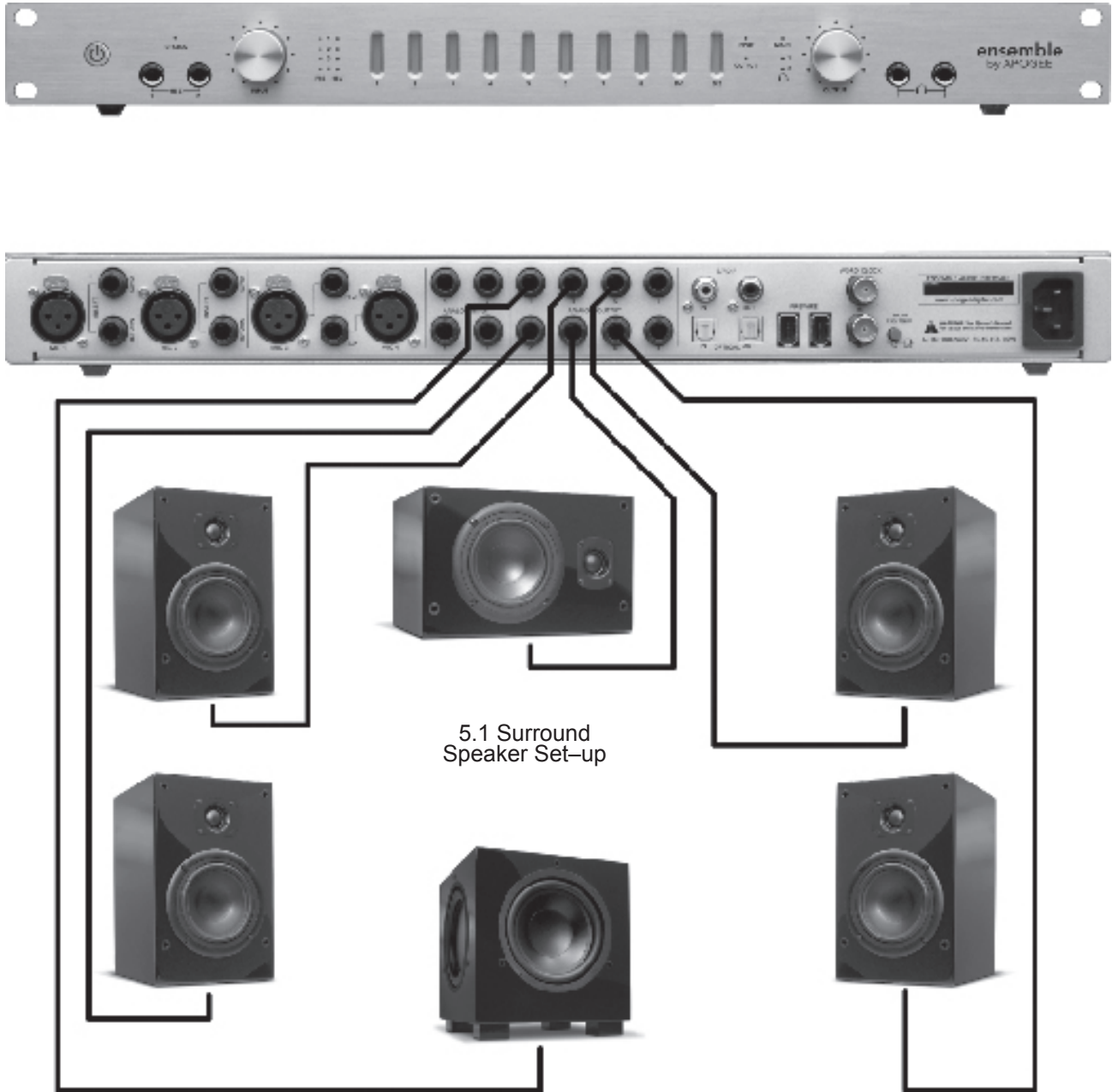

Configuring Audio Software Apps

Configuring Ensemble for use with audio software apps

When configuring Ensemble for use with Core Audio applications it’s necessary to:

- 1) select Ensemble in the hardware drivers menu;
- 2) open a software control panel to control Ensemble’s settings.

Apple Soundtrack Pro

To select Ensemble as hardware I/O:

1. Playback – open the OS X utility Audio Midi Setup (AMS), found in the Applications > Utilities folder and set **Default Output** to **Ensemble**. (figure 24)
2. Recording – in Soundtrack Pro, open **Window > Recording** and set **Input** and **Monitor Device** to **Ensemble**. (figure 25)

To control Ensemble’s settings:

1. In Apogee Maestro, open **Window > Settings**.

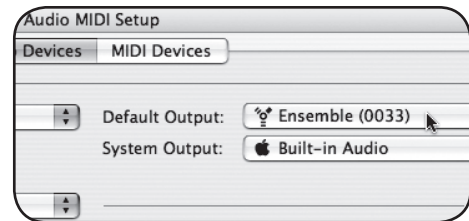

figure 24



figure 25

Apple Final Cut Pro

To select Ensemble as hardware I/O:

1. Playback – Open **Final Cut Pro > Audio Video Settings** and set **Audio Playback** to **Ensemble**. (figure 26)
2. Recording – Open **Tools > Voiceover** and set **Source** to **Ensemble**. (figure 27)

To control Ensemble’s settings:

1. In Apogee Maestro, open **Window > Settings**.

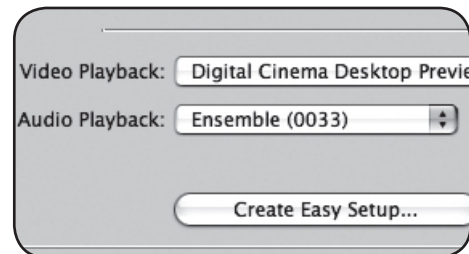

figure 26

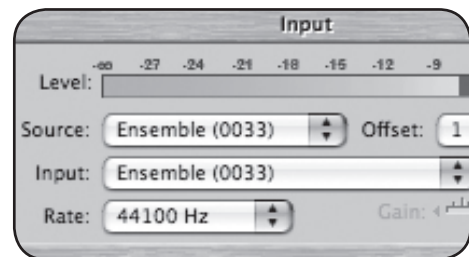

figure 27

Configuring Audio Software Apps

MOTU Digital Performer

To select Ensemble as hardware I/O:

1. In Digital Performer, open **Setup > Configure Audio System > Configure Hardware Driver.** (figure 28)
2. Set **Master Device** to **Ensemble** (figure 29)
3. Set **Work Priority** to **Low** (figure 29)

To control Ensemble’s settings:

1. In Apogee Maestro, open **Window > Settings.**

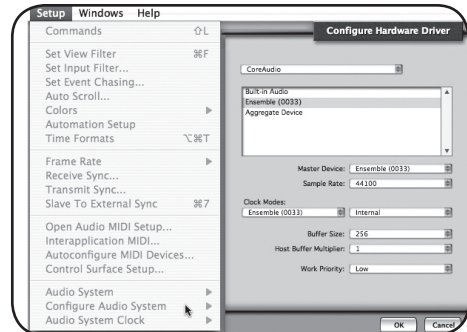

figure 28

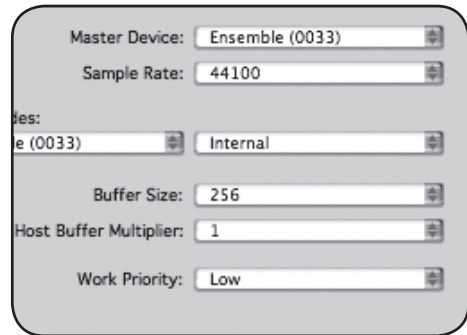

figure 29

Steinberg Nuendo

To select Ensemble as hardware I/O:

1. In Nuendo, open **Devices > Device Setup** and select **VST Audiobay** in the **Devices** column. (figure 30)
2. Set **Master ASIO Driver** to **Ensemble**. (figure 31)
3. When queried “Do you want to select another MASTER ASIO driver?”, click “**Switch**”.

To control Ensemble’s settings:

1. In Apogee Maestro, open **Window > Settings.**



figure 30

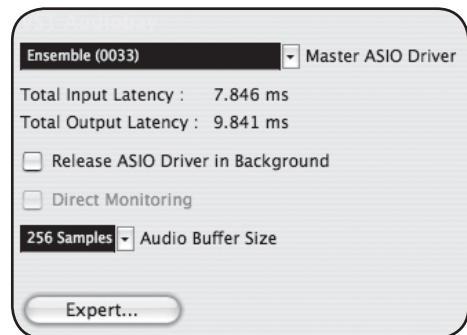

figure 31

Troubleshooting

The power switch's blue LED is lit, but no other LEDs are on; is the unit in operation?

- Not yet; when Ensemble is connected to AC power, the power switch illuminates dimly to indicate that the unit is in Standby. Press the power switch to power up Ensemble.

How can I quickly verify if the Ensemble system is operating correctly?

- Verify that Ensemble's **STATUS** LED is solid blue (verifies Ensemble hardware clocks);
- Check that the unit appears in AMS by serial number (verifies Firewire audio connection);
- open Maestro (or Logic Pro Apogee Control Panel), click on "Identify Unit" and verify that all LEDs light (verifies Firewire software control connection).

Ensemble doesn't show up in my audio program or in Audio Midi Setup.

- Verify that the required version of OS X is installed
- Is Ensemble's **STATUS** LED solid blue? If not, re-connect the Firewire cable or replace the cable.

I can't control Ensemble from Maestro or Logic Pro Apogee Control Panel.

- Verify the presence of this file : System > Library > Extensions > **apogfwplugin.bundle**. If you don't find it, re-install software from the CD included with Ensemble.

There's no signal on Analog output 1–2.

- Open Maestro, set **Meter Display** to **Output**, and verify that a signal is displayed on the meters. If no signal, check routing from the software audio application. If signal is displayed on the meters but not present at Analog outputs 1–2, check that the MAIN output level is up (either in Maestro or using the front panel **OUTPUT** encoder).

The front panel OUTPUT encoder knob doesn't attenuate the signal on Analog output 1–2.

- When **Format Select** is set to **None** (in Maestro), the front panel OUTPUT encoder does *not* attenuate output level. Set **Format Select** to **Stereo**.

The meters aren't working at all.

- Verify the **METER** setting in the Apogee Control Panel in Logic, it might be set to OFF.

Troubleshooting

I want to run Ensemble at 176.4 –192 kHz, but I only see 44.1–96 kHz in AMS.

- Ensemble can operate at sample rates of 44.1 to 96 kHz or 176.4 to 192 kHz, as determined by the **Sample Rate Range** setting in the Apogee Maestro **Settings** panel. To change the sample rate range, open the **Maestro>Window>Settings** panel and set **Sample Rate Range** to the desired setting. When setting the range, quit all audio software apps and allow 30 seconds for Ensemble to reboot at the new sample rate range

I'm trying to lock Ensemble to an external source, but the STATUS LED just won't stop blinking.

- When Ensemble is locked to an external source, Ensemble's sample rate is still determined by the selection in software. Thus, the sample rate of the external source must be manually set to match the software sample rate. For example, if you want to open a session at 88.2 kHz but lock Ensemble to word clock from an Apogee Big Ben, you must manually set the Big Ben to 88.2 kHz.

How do I reset Ensemble to its default settings?

- Ensemble may be reset by pressing in the front panel left encoder and then powering on the unit; continue to press the encoder until the unit has completed its boot-up sequence.

Warnings & Copyrights

FCC warning

This equipment has been tested and found to comply with the limits for a Class A digital device, pursuant to Part 15 of the FCC rules. These limits are designed to provide reasonable protection against harmful interference when operated in a commercial environment. This equipment generates, uses, and can radiate radio frequency energy and, if not installed and used in accordance with the instruction manual, may cause harmful interference to radio communications. Operation of this equipment in a residential area is likely to cause harmful interference, in which case the user will be required to take whatever measures necessary to correct the interference at his own expense.

Copyright Notice

The Apogee Ensemble is a computer-based device, and as such contains and uses software in ROMs. This software, and all related documentation, including this User’s Guide contain proprietary information which is protected by copyright laws. All rights are reserved. No part of the software and its related documentation may be copied, transferred, or modified. You may not modify, adapt, translate, lease, distribute, resell for profit or create derivative works based on the software and its related documentation or any part thereof without prior written consent from Apogee Electronics Corporation, U.S.A.

Software Notice

Redistribution and use in source and binary forms, with or without modification, are permitted provided that the following conditions are met:

- Redistributions of source code must retain the above copyright notice, this list of conditions and the following disclaimer.
- Redistributions in binary form must reproduce the above copyright notice, this list of conditions and the following disclaimer in the documentation and/or other materials provided with the distribution.

THIS SOFTWARE IS PROVIDED BY THE COPYRIGHT HOLDERS AND CONTRIBUTORS “AS IS” AND ANY EXPRESS OR IMPLIED WARRANTIES, INCLUDING, BUT NOT LIMITED TO, THE IMPLIED WARRANTIES OF MERCHANTABILITY AND FITNESS FOR A PARTICULAR PURPOSE ARE DISCLAIMED. IN NO EVENT SHALL THE COPYRIGHT OWNER OR CONTRIBUTORS BE LIABLE FOR ANY DIRECT, INDIRECT, INCIDENTAL, SPECIAL, EXEMPLARY, OR CONSEQUENTIAL DAMAGES (INCLUDING, BUT NOT LIMITED TO, PROCUREMENT OF SUBSTITUTE GOODS OR SERVICES; LOSS OF USE, DATA, OR PROFITS; OR BUSINESS INTERRUPTION) HOWEVER CAUSED AND ON ANY THEORY OF LIABILITY, WHETHER IN CONTRACT, STRICT LIABILITY, OR TORT (INCLUDING NEGLIGENCE OR OTHERWISE) ARISING IN ANY WAY OUT OF THE USE OF THIS SOFTWARE, EVEN IF ADVISED OF THE POSSIBILITY OF SUCH DAMAGE.

Declarations of Conformity

Declaration of Conformity—FCC

Apogee Ensemble

This device complies with Part 15 of the FCC Rules. Operation is subject to the following two conditions:

(1) This device may not cause harmful interference

(2) This device must accept any interference received, including interference that may cause undesired operation.

This equipment has been tested and found to comply with the limits of a Class B digital device, pursuant to Part 15 of the FCC Rules. These limits are designed to provide reasonable protection against harmful interference in a residential installation. This equipment generates, uses and can radiate radio frequency energy and, if not installed and used in accordance with the instructions, may cause harmful interference to radio communications. If this equipment does cause harmful interference to radio or television reception, which can be determined by turning the equipment off and on, the user is encouraged to try to correct the interference by one or more of the following measures:

1. Re-orient or relocate the receiving antenna.
2. Increase the separation between the equipment and receiver.
3. Connect the equipment into an outlet on a different circuit from that to which the receiver is connected.
4. Consult the dealer or an experienced radio/TV technician for help.

NOTE: The use of non-shielded cable with this equipment is prohibited.

CAUTION: Changes or modifications not expressly approved by the manufacturer responsible for compliance could void the user's authority to operate the equipment.

Apogee Electronics Corporation, 1715 Berkeley St, Santa Monica, CA 90404.
Betty Bennett, CEO.

Industry Canada Notice

This Class B digital apparatus meets all requirements of the Canadian Interference-Causing Equipment Regulations. Cet appareil numérique de la classe B respecte toutes les exigences du Règlement sur le matériel brouilleur du Canada.

Declaration of Conformity – CE

Apogee Electronics Corporation hereby declares that the product, the Ensemble, to which this declaration relates, is in material conformity with the following standards or other normative documents:

- EN50081–1/EN55022; 1995
- EN50082–1/IEC 801–2, 3, 4; 1992

following the provisions of:

- 73/23/EEC – Low Voltage Directive
- 89/336/EEC – EMC Directive

Declaration of Conformity – Japan

Apogee Electronics Corporation hereby declares that the Ensemble, to which this declaration relates, is in material conformity with the VCCI Class A standard.

Declaration of Conformity – Australia

Apogee Electronics Corporation hereby declares that the Ensemble is in material conformity with AN/NZS standard requirements.

Registration and Warranty Information

Be sure to register your Ensemble, either by filling in the enclosed Registration Card or by completing the on-line registration form at our Web site: <http://www.apogeedigital.com/support/>. If you do so, Apogee can contact you with any update information. As enhancements and upgrades are developed, you will be contacted at the registration address. Firmware updates are free for the first year of ownership unless otherwise stated. Please address any inquiries to your dealer or directly to Apogee at:

APOGEE ELECTRONICS CORPORATION,
1715 Berkeley St, Santa Monica, CA 90404, USA.
TEL: (310) 584-9394, FAX: (310) 584-9385
Email: support@apogeedigital.com. Web: <http://www.apogeedigital.com/>

APOGEE ELECTRONICS CORPORATION warrants this product to be free of defects in material and manufacture under normal use for a period of 12 months. The term of this warranty begins on the date of sale to the purchaser. Units returned for warranty repair to Apogee or an authorized Apogee warranty repair facility will be repaired or replaced at the manufacturer's option, free of charge.

ALL UNITS RETURNED TO APOGEE OR AN AUTHORIZED APOGEE REPAIR FACILITY MUST BE PREPAID, INSURED AND PROPERLY PACKAGED, PREFERABLY IN THEIR ORIGINAL BOX. Apogee reserves the right to change or improve design at any time without prior notification. Design changes are not implemented retroactively, and the incorporation of design changes into future units does not imply the availability of an upgrade to existing units.

This warranty is void if Apogee determines, in its sole business judgment, the defect to be the result of abuse, neglect, alteration or attempted repair by unauthorized personnel.

The warranties set forth above are in lieu of all other warranties, expressed or implied, and Apogee specifically disclaims any and all implied warranty of merchantability or of fitness for a particular purpose. The buyer acknowledges and agrees that in no event shall the company be held liable for any special, indirect, incidental or consequential damages, or for injury, loss or damage sustained by any person or property, that may result from this product failing to operate correctly at any time.

USA: Some states do not allow for the exclusion or limitation of implied warranties or liability for incidental or consequential damage, so the above exclusion may not apply to you. This warranty gives you specific legal rights, and you may have other rights which vary from state to state.

Service Information

The Ensemble contains no user-serviceable components: refer to qualified service personnel for repair or upgrade. Your warranty will be voided if you tamper with the internal components. If you have any questions with regard to the above, please contact Apogee.

In the event your Ensemble needs to be upgraded or repaired, it is necessary to contact Apogee prior to shipping, and a Return Materials Authorization (RMA) number will be assigned. This number will serve as a reference for you and helps facilitate and expedite the return process. Apogee requires that shipments be pre-paid and insured — unless otherwise authorized in advance.

IMPORTANT: ANY SHIPMENT THAT IS NOT PRE-PAID OR IS SENT WITHOUT AN RMA NUMBER WILL NOT BE ACCEPTED.

User's Guide

V1.6 - April 2008

