

ULTRAGAIN[®] PRO MIC2200

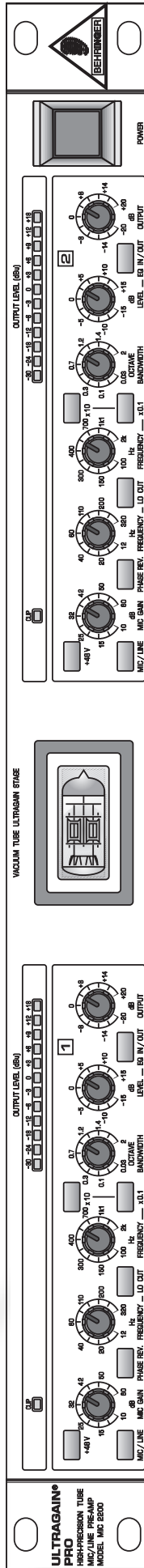

User's Manual Bedienungsanleitung

Version 1.0 May 1998

E
D



www.behringer.de



EG-Declaration of Conformity



INTERNATIONAL GmbH

acc. to the Directives 89/336/EWG and 73/23/EWG

We,

BEHRINGER INTERNATIONAL GmbH

Hanns-Martin-Schleyer-Straße 4

D - 47877 Willich

Name and address of the manufacturer or the introducer of the product on the market who is established in the EC

herewith take the sole responsibility to confirm that the product:

ULTRAGAIN PRO MIC2200

Type designation and, if applicable, Article-N°

which refers to this declaration, is in accordance with the following standards or standardized documents:

EN 60065

EN 61000-3-2

EN 55020

EN 61000-3-3

EN 55013

The following operation conditions and installation arrangements have to be presumed:

acc. to Operating Manual

BEHRINGER
INTERNATIONAL GmbH
Hanns-Martin-Schleyer-Str. 36-38
D-47877 Willich, Merckstraße II
Tel.-Nr. 0 21 54 / 92 06-0
Fax-Nr. 0 21 54 / 92 06-30

B. Nier, President

Willich, 01.05.1998

Name, address, date and legally binding signature of the person responsible

SAFETY INSTRUCTIONS

CAUTION: To reduce the risk of electrical shock, do not remove the cover (or back). No user serviceable parts inside; refer servicing to qualified personnel.



WARNING: To reduce the risk of fire or electrical shock, do not expose this appliance to rain or moisture.



This symbol, wherever it appears, alerts you to the presence of uninsulated dangerous voltage inside the enclosure - voltage that may be sufficient to constitute a risk of shock.



This symbol, wherever it appears, alerts you to important operating and maintenance instructions in the accompanying literature. Read the manual.

DETAILED SAFETY INSTRUCTIONS:

All the safety and operation instructions should be read before the appliance is operated.

Retain Instructions:

The safety and operating instructions should be retained for future reference.

Heed Warnings:

All warnings on the appliance and in the operating instructions should be adhered to.

Follow instructions:

All operation and user instructions should be followed.

Water and Moisture:

The appliance should not be used near water (e.g. near a bathtub, washbowl, kitchen sink, laundry tub, in a wet basement, or near a swimming pool etc.).

Ventilation:

The appliance should be situated so that its location or position does not interfere with its proper ventilation. For example, the appliance should not be situated on a bed, sofa rug, or similar surface that may block the ventilation openings: or placed in a built-in installation, such as a bookcase or cabinet that may impede the flow of air through the ventilation openings.

Heat:

The appliance should be situated away from heat sources such as radiators, heat registers, stoves, or other appliance (including amplifiers) that produce heat.

Power Source:

The appliance should be connected to a power supply only of the type described in the operating instructions or as marked on the appliance.

Grounding or Polarization:

Precautions should be taken so that the grounding or polarization means of an appliance is not defeated.

Power-Cord Protection:

Power supply cords should be routed so that they are not likely to be walked on or pinched by items placed upon or against them, paying particular attention to cords and plugs, convenience receptacles and the point where they exit from the appliance.

Cleaning:

The appliance should be cleaned only as recommended by the manufacturer.

Non-use Periods:

The power cord of the appliance should be unplugged from the outlet when left unused for a long period of time.

Object and Liquid Entry:

Care should be taken so that objects do not fall and liquids are not spilled into the enclosure through openings.

Damage Requiring Service:

The appliance should be serviced by qualified service personnel when:

- The power supply cord or the plug has been damaged; or
- Objects have fallen, or liquid has been spilled into the appliance; or
- The appliance has been exposed to rain; or
- The appliance does not appear to operate normally or exhibits a marked change in performance; or
- The appliance has been dropped, or the enclosure damaged.

Servicing:

The user should not attempt to service the appliance beyond that is described in the Operating Instructions. All other servicing should be referred to qualified service personnel.



ULTRAGAIN PRO

Ultra-low noise discrete Microphone/Line Preamplifier

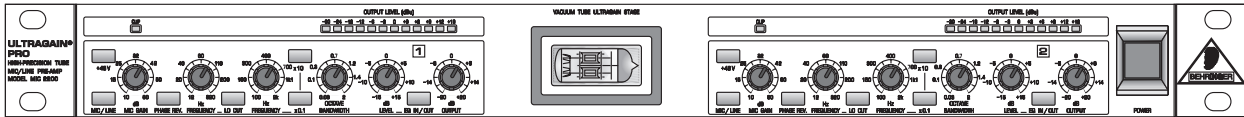

- ▲ Mic input stages are based on super-high quality, discrete conjugate transistor pair circuitry
- ▲ Ultra-wide bandwidth from 2 Hz to 200 kHz for “open” sound
- ▲ Built-in high-quality vacuum tube for outstanding, ultra-musical tube sound
- ▲ Our special vacuum tube circuitry warms up your music without unwanted noise
- ▲ Two high-end Parametric EQs with centre frequency, bandwidth and level being fully user adjustable
- ▲ Independent line driver to convert -10 dBV into +4 dBu pro level
- ▲ Completely versatile DI-Box due to servo-balanced inputs and outputs
- ▲ “Soft Mute” +48 V Phantom Power to avoid switch-on “thumps”
- ▲ Fully tunable and switchable 12 dB high-pass filter
- ▲ Switchable Phase Reverse to correct phase problems
- ▲ Ultra-low noise 4580 audio operational amplifiers for outstanding sound performance
- ▲ Accurate 12-segment LED metering for output level
- ▲ Servo-balanced gold-plated XLR and 1/4” TRS inputs and outputs
- ▲ Relay-controlled input switch for maximum signal integrity
- ▲ High-quality detented potentiometers and illuminated switches
- ▲ Manufactured under the stringent ISO9000 management system

FOREWORD

Dear Customer,

Welcome to the team of ULTRAGAIN PRO users and thank you very much for expressing your confidence in BEHRINGER products by purchasing this unit.

It is one of my most pleasant tasks to write this letter to you, because it is the culmination of many months of hard work delivered by our engineering team to reach a very ambitious goal: making an outstanding device better still. The ULTRAGAIN has for quite a long time been a standard tool used by numerous studios and P.A. rental companies. The task to improve one of our best-selling products certainly meant a great deal of responsibility, which we assumed by focusing on you, the discerning user and musician. It also meant a lot of work and night shifts to accomplish this goal. But it was fun, too. Developing a product usually brings a lot of people together, and what a great feeling it is when everybody who participated in such a project can be proud of what we've achieved.

It is our philosophy to share our joy with you, because you are the most important member of the BEHRINGER family. With your highly competent suggestions for new products you've greatly contributed to shaping our company and making it successful. In return, we guarantee you uncompromising quality (manufactured under ISO9000 certified management system) as well as excellent technical and audio properties at an extremely favorable price. All of this will enable you to fully unfold your creativity without being hampered by budget constraints.

We are often asked how we can make it to produce such high-grade devices at such unbelievably low prices. The answer is quite simple: it's you, our customers! Many satisfied customers means large sales volumes enabling us to get better conditions of purchase for components, etc. Isn't it only fair to pass this benefit back to you? Because we know that your success is our success, too!

I would like to thank all people whose help on "Project ULTRAGAIN PRO" has made it all possible. Everybody has made very personal contributions, starting from the designers of the unit via the many staff members in our company to you, the user of BEHRINGER products.

My friends, it's been worth the trouble!

Thank you very much,

A handwritten signature in black ink, appearing to read 'U. Behringer', with a long horizontal flourish extending to the right.

Uli Behringer



TABLE OF CONTENT

1. INTRODUCTION	7
1.1 Technical background	8
1.1.1 Noise as a physical phenomenon	8
1.1.2 What are audio dynamics?	8
1.2 The tube used in the ULTRAGAIN PRO	9
1.2.1 Tube history	9
1.2.2 Design and functional principle of tubes	10
1.2.3 Properties of tubes	11
1.2.4 The best of both worlds	12
1.2.5 Studio applications	12
2. THE DESIGN CONCEPT	12
2.1 High quality components and design	12
2.2 Inputs and outputs	12
2.2.1 Balanced inputs and outputs	12
3. INSTALLATION	12
3.1 Rack mounting	13
3.2 Mains voltage	13
3.3 Audio connections	13
4. CONTROLS	14
4.1 Front panel control elements	15
4.2 Rear panel control elements	16
5. APPLICATIONS	16
5.1 The ULTRAGAIN PRO as a microphone preamplifier	17
5.1.1 Basic setting	17
5.1.2 MIC GAIN control	17
5.1.3 PHASE REV. switch	17
5.1.4 LO CUT function	18
5.1.5 Phantom power	18
5.2 The ULTRAGAIN PRO as a level translator	19
5.3 The ULTRAGAIN PRO as a direct-injection box	19
5.4 The ULTRAGAIN PRO's parametric equalizer	19
5.5 The ULTRAGAIN PRO as a tube interface	20
6. SPECIFICATIONS	20
7. WARRANTY	22

1. INTRODUCTION

With the ULTRAGAIN PRO you have purchased an extremely musical and flexible microphone preamplifier. Our ULTRAGAIN range of devices has been a hit ever since we introduced our first model some 5 years ago. This high-end microphone preamp is based on many years of experience and findings in amplifier technology and is used throughout the world in renowned studios, sound reinforcement systems as well as in broadcast and television studios. Improving the legendary ULTRAGAIN even further was a real challenge, and we are proud of our success. The BEHRINGER ULTRAGAIN PRO meets highest and no-compromise requirements in terms of operation, sound, specifications and workmanship.

Future-oriented BEHRINGER technology

Compared to its predecessor models, the ULTRAGAIN PRO not only has additional features, but also boasts dramatically enhanced audio qualities. For example, it uses a special tube stage to provide the program material with typical tube “warmth”, and has a fully parametric equalizer per channel, which gives you even more sound-processing flexibility.

The heart of the ULTRAGAIN PRO is an extremely low-noise microphone preamp circuit that uses discrete components to produce a highly transparent sound. In combination with our BEHRINGER tube technology, the operational amplifiers 4580 and a sophisticated circuit topology, the ULTRAGAIN PRO yields excellent noise and distortion properties! The switchable +48 V phantom power supply allows for connecting almost any kind of microphone and suppresses power-up thumps with its “soft mute” function.

BEHRINGER tube circuitry

Our engineering team has made it possible to enhance the traditional tube circuitry (particularly for our ULTRAGAIN PRO) and adapt it to meet the high sound quality and dynamics requirements of modern, pro-level audio technology. The fact that we are still fascinated by “antique” tube radios and amps as well as the fine and warm tonal character that we usually associate with them, are the reasons why vacuum tubes have kept their ground even in state-of-the-art circuit topologies used especially in professional audio technology or so-called high-end devices. We are particularly proud that we have found a highly effective symbiosis between solid-state and tube technologies making them affordable to almost anybody in audio technology.

The parametric equalizer

Parametric equalizers represent the most advanced form of equalization systems. Basically, the user has control over the three parameters that define the so-called Gaussian equalization curve: bandwidth, frequency and amplitude.

The ULTRAGAIN PRO’s on-board parametric equalizer combines the technical properties of a parametric equalizer with those of a narrow-band notch filter. Capable of eliminating feedback frequencies, a parametric equalizer is a perfect match for a microphone preamp. Moreover, as its design is based on our well-known ULTRA-Q, the ULTRAGAIN PRO’s audio qualities and specifications are well within the so-called “high-end” class. Its on-board equalizer can be used not only to “tweak” the frequency response but also to creatively process audio material, thus giving you undreamed of equalization flexibility. Both in creative audio-processing applications in recording and broadcast/TV studios, in video post-production, and on stage, equalizers are highly efficient and all-purpose audio tools ideally complementing microphone preamps.

The universal level translator

In addition to a high-grade microphone preamp, the ULTRAGAIN PRO features a separate level translator which can both raise and lower line level signals. You can use it to translate home recording to studio levels so as to easily connect tape/video recorders and other hi-fi devices to professional equipment (and vice versa, i.e. reducing studio levels to match those of semi-professional equipment).

 **The following operational manual will introduce you to the BEHRINGER ULTRAGAIN PRO and its various functions. After reading the manual carefully, make sure it is always on hand for future reference.**

1.1 Technical background

By employing current modern analog technology it is possible to manufacture audio equipment with a dynamic range of up to 130 dB. In contrast to analog techniques, the dynamic range of digital equipment is approximately 25 dB less. With conventional record and tape recorder technology, as well as broadcasting, this value is further reduced. Generally, dynamic restrictions are due to noisy storage in transmission media and also the maximum headroom of these systems.

1.1.1 Noise as a physical phenomenon

All electrical components produce a certain level of inherent noise. Current flowing through a conductor leads to uncontrolled random electron movements. For statistical reasons, this produces frequencies within the whole audio spectrum. If these currents are highly amplified, the result will be perceived as noise. Since all frequencies are equally affected, we term this *white* noise. It is fairly obvious that electronics cannot function without components. Even if special low-noise components are used, a certain degree of basic noise cannot be avoided.

This effect is similar when replaying a tape. The non-directional magnetic particles passing the replay head can also cause uncontrolled currents and voltages. The resulting sound of the various frequencies is heard as noise. Even the best possible tape biasing can “only” provide signal-to-noise ratios of about 70 dB, which is not acceptable today since the demands of listeners have increased. Due to the laws of physics, improving the design of the magnetic carrier is impossible using conventional means.

1.1.2 What are audio dynamics?

A remarkable feature of the human ear is that it can detect the most wide ranging amplitude changes - from the slightest whisper to the deafening roar of a jet-plane. If one tried to record or reproduce this wide spectrum of sound with the help of amplifiers, cassette recorders, records or even digital recorders (CD, DAT etc.), one would immediately be restricted by the physical limitations of electronic and acoustic sound reproduction technology.

The usable dynamic range of electro-acoustic equipment is limited as much at the low end as at the high end. The thermal noise of the electrons in the components results in an audible basic noise floor and thus represents the bottom limit of the transmission range. The upper limit is determined by the levels of the internal operating voltages; if they are exceeded, audible signal distortion is the result. Although in theory, the usable dynamic range sits between these two limits, it is considerably smaller in practice, since a certain reserve must be maintained to avoid distortion of the audio signal if sudden level peaks occur. Technically speaking, we refer to this reserve as “headroom” - usually this is about 10 - 20 dB. A reduction of the operating level would allow for greater headroom, i.e. the risk of signal distortion due to level peaks would be reduced. However, at the same time, the basic noise floor of the program material would be increased considerably.

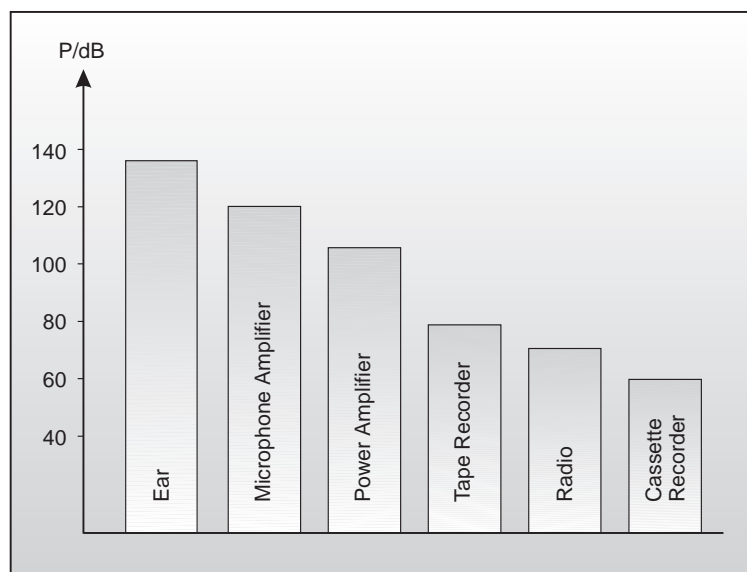

Fig. 1.1: The dynamic range capabilities of various devices

It is therefore useful to keep the operating level as high as possible without risking signal distortion in order to achieve optimum transmission quality.

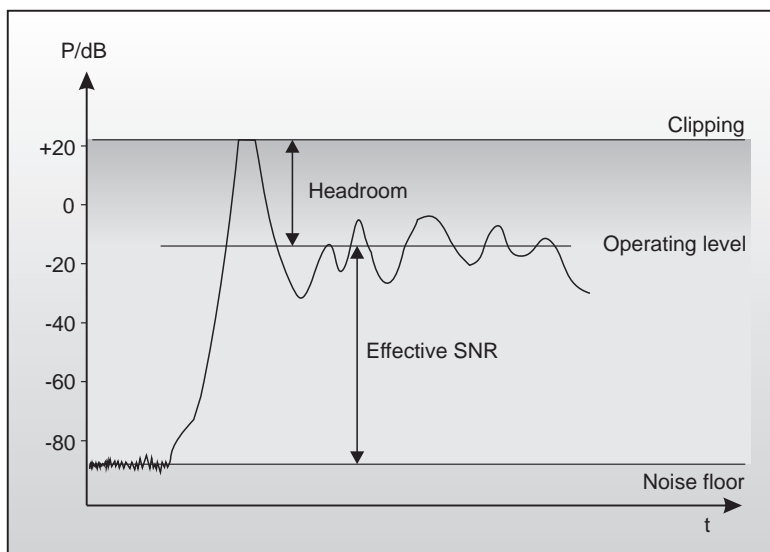

Fig. 1.2: The interactive relationship between the operating level and the headroom

1.2 The tube used in the ULTRAGAIN PRO

A closer look at developments and trends in audio technology shows that tubes are enjoying a renaissance today, in a time when even amateur musicians are free to use digital effects processors and recording media, and ever more affordable digital mixing consoles are becoming a natural part of the equipment of many semi-professional studios. Manufacturers try with ever new algorithms to get the most out of DSP's (Digital Signal Processors), the heart of any digital system.

Still, many audio engineers, particularly old hands often prefer using both old and new tube-equipped devices. As they want to use their warm sound character for their productions, they are ready to accept that these "little darlings" produce a higher noise floor than modern, transistor-based devices. As a consequence, you can find a variety of tube-based microphones, equalizers, preamps and compressors in today's recording and mastering environments. The combination of semiconductor and tube technologies gives you the additional possibility of using the best of both worlds, while being able to make up for their specific drawbacks.

1.2.1 Tube history

Due to many patent litigations, it is difficult to determine exactly when the tube was "born". First developments in tube technology were reported between 1904 and 1906. It was a research task of that time to find a suitable method for receiving and rectifying high frequencies. On April 12, 1905, a certain Mr. Fleming was granted a patent for his "hot-cathode valve" which was based on Edison's incandescent lamp. This valve was used as a rectifier for high-frequency signals. Robert von Lieben was the first to discover (probably by chance) that the anode current can be controlled by means of a perforated metal plate (grid) – one of the milestones in the development of amplification tubes. In 1912, Robert van Lieben finally developed the first tube for the amplification of low-frequency signals. Initially, the biggest problem was to produce sufficient volume levels, which is why resonance step-ups (though impairing the frequency response) were used to maximize the attainable volume. Later, the objective was to optimize the electroacoustic transducers of amplifiers in such a way that a broad frequency band could be transmitted with the least distortion possible.

However, a tube-specific problem is its non-linear amplification curve, i.e. it modifies the sound character of the source material. Despite all efforts to ensure a largely linear frequency response, it had to be accepted that tube devices produce a "bad" sound. Additionally, the noise floor generated by the tubes limited the usable dynamics of connected storage media (magnetic tape machines). Thus, a one-to-one reproduction of the audio signal's dynamics (expressed as the difference between the highest and lowest loudness levels of the program material) proved impossible. To top it all, tube devices required the use of high-quality and often costly transducers and sophisticated voltage supplies.



With the introduction of semiconductor technologies in the field of audio amplification, it soon became clear that the tube would have to give way to the transistor, as this device featured an enormously enhanced signal-to-noise ratio, required a less complex power supply and yielded an improved frequency response. Plus, semiconductor-based circuits can be realized much more easily - for less money.

Two decades later, the introduction of binary signal processing meant the beginning of a new era of recording media that provided plenty of dynamic response and allowed for the loss-free copying of audio signals. As digital media were enhanced, however, many people began to miss the warmth, power and liveliness they knew from analog recordings. This is why purists still today consider digital recordings as "sterile" in sound.

1.2.2 Design and functional principle of tubes

Tubes can be roughly classified according to the number of electrodes they use. There are tubes with two, three or five electrodes usually referred to as diodes, triodes or pentodes.

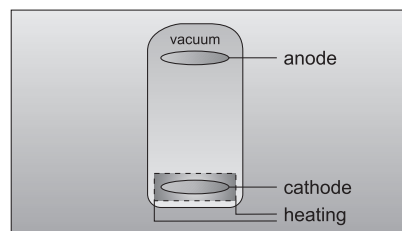

Fig. 1.3: diode

The *diode* contains two electrodes in a vacuum glass bulb that have electrical connection to the outside. The vacuum allows for a free movement of electrons. When one of the electrodes is heated up (= thus becoming a cathode), it begins to emit electrons. When a positive DC voltage is applied to the other electrode (= anode), the negative electrons start to migrate from the cathode to the anode. With reverse polarity between cathode and anode, a current flow is not possible because the unheated anode emits more or less no electrons. This design was used, for example, as a rectifier in the power supplies of amplifiers. The magnitude and velocity of the flow of electrons depend on the cathode's temperature, the material it consists of, and the magnitude of the anode voltage. When the electrons hit the anode they produce heat that is dissipated by using large anode plates.

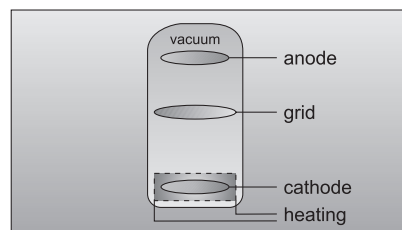

Fig. 1.4: triode

The *triode* has an additional metal grid between anode and cathode. By applying a negative voltage, this grid can be used to control the internal resistance of the tube, and hence the anode current. When the grid bias voltage (voltage between cathode and grid) becomes negative, the current flowing to the anode is reduced because the negatively charged grid repels the arriving electrons. As a consequence, there are less electrons to reach the anode. When the bias voltage is raised towards zero, the flow of electrons accelerates. When it finally becomes zero or even positive, the grid current begins to flow which considerably reduces the current flowing to the anode and can possibly destroy the tube. Triodes are most commonly used in preamps, often in pairs arranged in one tube (twin triode).

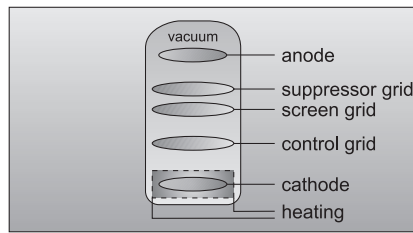

Fig. 1.5: pentode

In a triode the capacitance between grid and anode is a problem with regard to high frequencies and large amplification factors. For this reason, the *pentode* has a positively charged screen grid between the control grid and the anode. However, the positive charge of the screen grid attracts electrons emitted from the anode plate when it is hit by arriving electrons. To prevent this electron emission, a decelerating or suppressor grid is placed between anode and screen grid. As it is negatively charged it blocks the electrons, so that they cannot reach the screen grid. Pentodes are most commonly used in power stages.

1.2.3 Properties of tubes

In general, the saturation (overdriving) of both transistor and tube-based circuits results in various types of distortion. These phenomena are quite complex in the real world, but for the sake of a straightforward mathematical description we are going to classify them as linear and non-linear distortion. Linear distortion is produced by frequency-dependent amplification or attenuation processes such as they occur in all kinds of filters and equalizers. Linear-distortion signals have the same frequency portions both on the input and output sides, but with different phase positions and amplitudes. Non-linear distortions have additional harmonics and distortion components that were not contained in the original input signal.

For example, when the simplest of all oscillations, a sine wave with a fixed frequency f , is overdriven, new oscillations with frequencies of $2*f$, $3*f$, etc. (integral multiples of the original frequency) are produced. These new frequencies are referred to as upper harmonics grouped as odd and even harmonics.

Unlike the transistor, saturated tubes mostly produce even harmonics which are perceived by the human ear as more pleasant in sound than odd harmonics. Another important aspect lies in the fact that tubes produce distortion more gradually than transistors, which is why we speak of the "saturation" of a tube stage. When you overdrive a transistor you get a sudden square deformation of the sine signal applied at the input, which produces an extreme harmonic spectrum at the output.

Non-linear distortions are measured with a distortion factor that consists of the total harmonic distortion $[k]$ and partial harmonic distortions $[k_n]$. The latter are defined as the ratio between the voltage of a single harmonic and the voltage of the distorted overall signal. Thus, the content of even harmonics is expressed as k_2, k_4, \dots and that of odd harmonics as k_1, k_3, \dots .

$$k_n = \frac{U_n}{U}$$

Formula for calculating partial harmonic distortion

The total harmonic distortion is the root of all squared distortion factors of the second and third degrees. Since the higher harmonics have only little impact on the measured results, they can be neglected.

$$k = \sqrt{k_2^2 + k_3^2}$$

Formula for calculating total harmonic distortion

In tube circuits the distortion factor k_2 is used to describe an effect which the human ear classifies as "pleasant". Also the frequency bands in which distortion occurs play an important role because the human ear differentiates very clearly, in particular, in the frequency range of human speech.



1.2.4 The best of both worlds

Despite many efforts neither manufacturers nor developers have succeeded so far in simulating these positive properties of the tube by means of other devices. Additionally, the natural capabilities of the tube to act as a soft limiter can only be mimicked with highly sophisticated circuitry. Today's studio technology requirements are therefore met by a combination of both high-grade semiconductor and tube technologies. In this context, tubes do not serve any longer their original purpose as amplifiers, but are used for the detailed shaping of the sound.

1.2.5 Studio applications

In a recording studio tubes have not the same task as they have in an overdriven guitar amp, where the considerably higher saturation of the tube(s) leads to a full and often deliberate modification of the input signal (in many cases combined with a heavy increase in noise floor levels). In the studio more subtle effects are needed. Here, tube circuits add life to the signal's tonal character and increase its power to make itself heard. Often, tubes also increase the signal's perceived loudness (in relation to the unprocessed signal), i.e. the perceived loudness goes up although the volume level remains the same. This is because the dynamic range of the applied audio signal is limited by the tube circuit, while the amplitude of the signal with the lowest loudness is raised. Thus, increasing tube saturation produces a slight compression effect over the entire dynamic range.

A similar effect can be perceived when analog tape is saturated. This saturation effect also compresses the recorded audio material and produces additional harmonics.

2. THE DESIGN CONCEPT

2.1 High quality components and design

The philosophy behind BEHRINGER products guarantees a no-compromise circuit design and employs the best choice of components. The operational amplifiers NJM4580 which are used in the ULTRAGAIN PRO, are exceptional. They boast extreme linearity and very low distortion characteristics. To complement this design the choice of components includes high tolerance resistors and capacitors, detent potentiometers and several other stringently selected elements.

For the first time, the ULTRAGAIN PRO MIC2200 uses SMD technology (Surface Mounted Device). These sub-miniature components known from aerospace technology allow for an extreme packing density, plus the unit's reliability could be improved. Additionally, the unit is manufactured in compliance with a ISO9000 certified management system.

2.2 Inputs and outputs

2.2.1 Balanced inputs and outputs

As standard, the BEHRINGER ULTRAGAIN PRO is installed with electronically servo-balanced inputs and outputs. The new circuit design features automatic hum and noise reduction for balanced signals and thus allows for trouble-free operation, even at high operating levels. Externally induced mains hum etc. will be effectively suppressed. The automatic servo-function recognizes the presence of unbalanced connectors and adjusts the nominal level internally to avoid level differences between the input and output signals (correction 6 dB).

3. INSTALLATION

Your BEHRINGER ULTRAGAIN PRO was carefully packed in the factory and the packaging was designed to protect the unit from rough handling. Nevertheless, we recommend that you carefully examine the packaging and its contents for any signs of physical damage, which may have occurred in transit.

 **If the unit is damaged, please do not return it to us, but notify your dealer and the shipping company immediately, otherwise claims for damage or replacement may not be granted. Shipping claims must be made by the consignee.**

3.1 Rack mounting

The BEHRINGER ULTRAGAIN PRO fits into one standard 19" rack unit of space (1 3/4"). Please allow at least an additional 4" depth for the connectors on the back panel. Be sure that there is enough air space around the unit for cooling and please do not place the ULTRAGAIN PRO on high temperature devices such as power amplifiers etc. to avoid overheating.



3.2 Mains voltage

Before you connect your ULTRAGAIN PRO to the mains, please make sure that your local voltage matches the voltage required by the unit! The fuse holder on the female mains connector has 3 triangular markers, with two of these triangles opposing each other. Your ULTRAGAIN PRO is set to the operating voltage printed next to these markers, and can be set to another voltage by turning the fuse holder by 180°. **CAUTION: this instruction does not apply to export models exclusively designed, e.g. for 115 V operation!**

 **Please refer to the specifications for detailed information about specific voltage supplies!**

3.3 Audio connections

The audio inputs and outputs on the BEHRINGER ULTRAGAIN PRO are fully balanced. If possible, connect the unit to other devices in a balanced configuration to allow for maximum interference immunity.

 **Please ensure that only qualified persons install and operate the ULTRAGAIN PRO. During installation and operation the user must have sufficient electrical contact to earth. Electrostatic charges might affect the operation of the ULTRAGAIN PRO!**

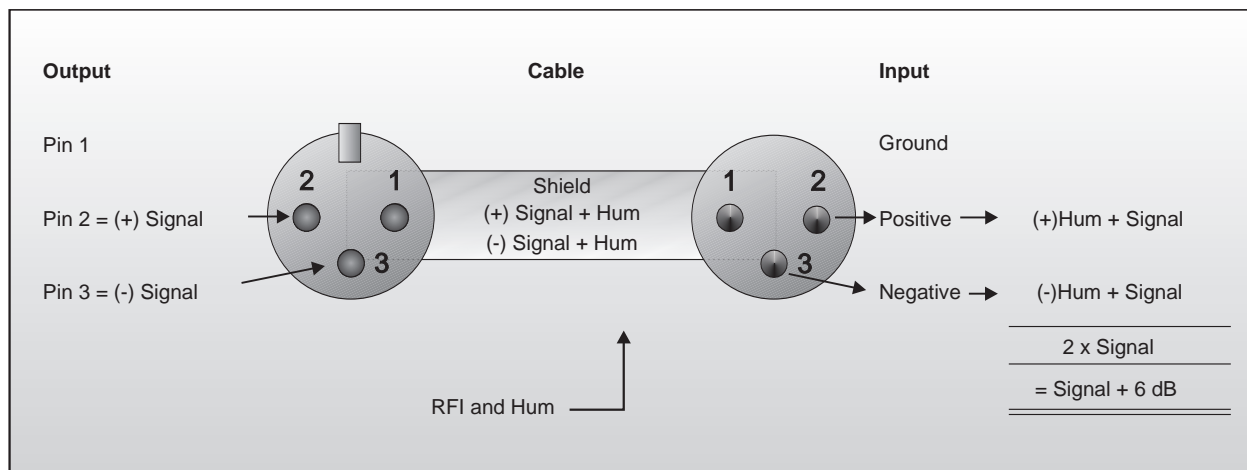

Fig. 3.1: Compensation of interference with balanced connections

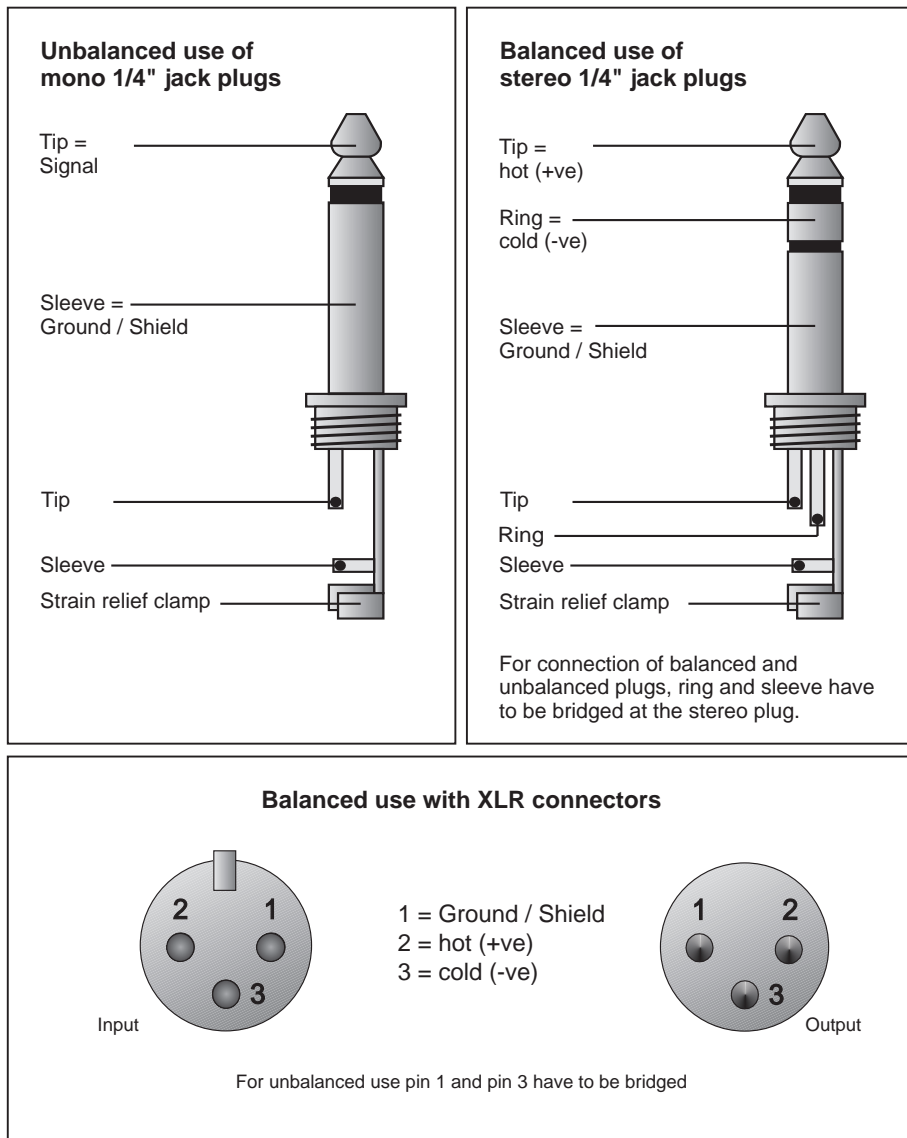

Fig. 3.2: Different plug types

⚠ Never use unbalanced XLR connections with microphone cables, as this would short-circuit any phantom power transmitted over these cables!

4. CONTROLS

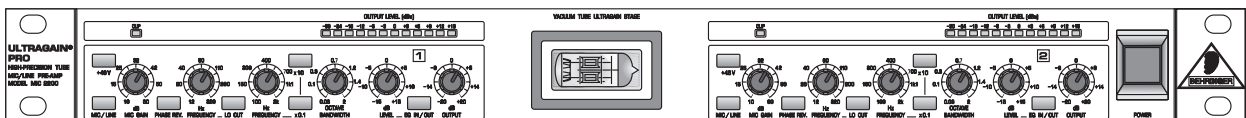

Fig. 4.1: ULTRAGAIN PRO front panel

The BEHRINGER ULTRAGAIN PRO has two identical channels. Each channel is equipped with 7 push buttons, 6 rotary controls and 13 LED's.

4.1 Front panel control elements

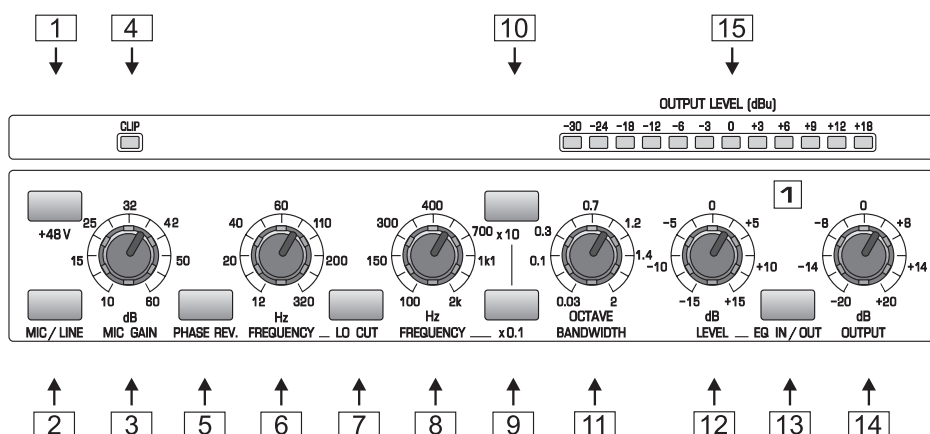



Fig. 4.2: Control elements on the front panel

- 1 This +48 V switch activates the +48 V phantom power circuit that uses the signal leads to supply condenser microphones with the required operating voltage.
-  **Please check the connected signal source for matching specifications before you switch phantom power on, so as to avoid damage to the microphone, etc.**
- 2 Use the *MIC/LINE* switch to toggle between MIC and LINE modes. When the switch is pressed, the unit works in MIC mode (now you can press the +48 V switch if required; in LINE mode this function is disabled).
-  **Please note that the input phone jack is disabled in MIC mode, i.e. you must use the XLR connector to access the microphone amp.**
- 3 The *MIC GAIN* control is enabled in MIC mode only and allows for applying gain from 10 to 60 dB to the input signal. In view of the extremely high gain levels that can be applied, you should verify that the gain control is properly set before you power up the unit. In case of doubt, set the control fully counter-clockwise, and start from there slowly raising the gain. High gain settings and the resulting levels can damage subsequent devices.
 - 4 The *CLIP* LED signals that a level of at least +18 dBU is present after the microphone amp stage. With too high a level the CLIP LED warns you to reduce the gain with the MIC GAIN control, so as to avoid distortion caused by overloading. During normal operation, the LED should not light up at all.
 - 5 With the *PHASE REV.* switch the input signal is reversed in phase by 180°. This function is available both in MIC and LINE modes.
 - 6 When the high-pass filter is switched on (*LO CUT* switch pressed), the *FREQUENCY* control defines the filter's cut-off frequency. With a setting range from 12 to 320 Hz the filter's main task is to eliminate bottom-end rumble noise, etc.
 - 7 The *LO CUT* switch activates/deactivates the high-pass filter.
- The following 6 control elements refer to the parametric equalizer only.**
- 8 The *FREQUENCY* control is used to select the frequency to be modified. Please note that the frequency range can be lowered/raised with the switches x0.1 and x10. In this way, you can process the entire audio range between 10 Hz and 20 kHz. With both switches out, the *FREQUENCY* control can be swept over a range from 100 Hz to 2 kHz.
 - 9 The x 0.1 switch lowers the working range of the *FREQUENCY* control to 10 - 200 Hz, so that you can process the bass end of the audio spectrum.
 - 10 The x 10 switch raises the working range of the *FREQUENCY* control to 1 - 20 kHz, so that you can process the treble end of the audio spectrum.

- 11 The *BANDWIDTH* control determines the slope or quality of the filter. Bandwidth ranges from 0.03 (Q=43) to 2 octaves (Q=0,67).
- 12 With the *LEVEL* control you can set the amount of level reduction/gain applied to the filter. The setting range is from -15 to +15 dB.
- 13 The *EQ IN/OUT* switch activates/deactivates the parametric EQ. Please switch the EQ off unless you need it for your specific audio application.
- 14 The *OUTPUT* control raises/lowers the output level of the device by a maximum of 20 dB (+/- 20 dB). With the control in mid-travel position, no level change is applied. Available both in MIC and LINE modes.
- 15 The *OUTPUT LEVEL* LED chain displays the output level within a range from -30 to +18 dB. The display is referenced to a level of +4 dBu.

4.2 Rear panel control elements

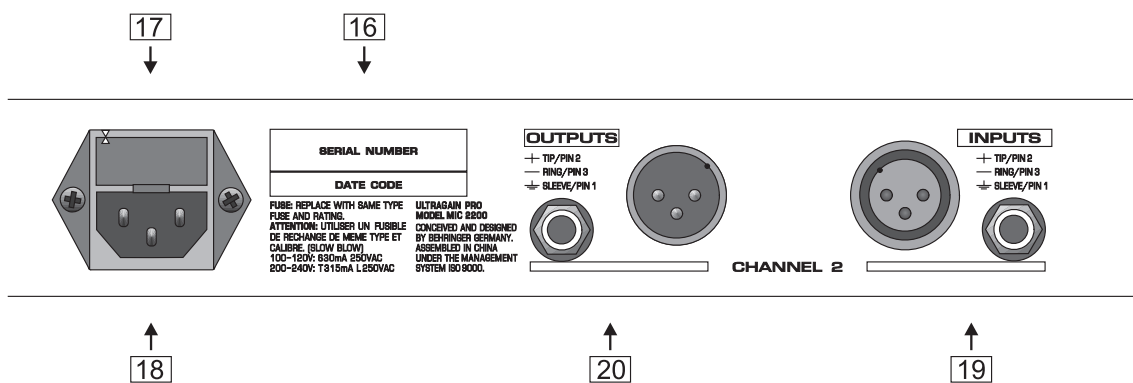

Fig. 4.3: Rear panel elements of the ULTRAGAIN PRO

- 11 *SERIAL NUMBER*. Please take the time to have the warranty card filled out completely by your specialized dealer and return it within 14 days after the date of purchase, so as to be entitled to benefit from our extended warranty.
- 12 *FUSE HOLDER / VOLTAGE SELECTOR*. Please make sure that your local voltage matches the voltage indicated on the unit, before you attempt to connect and operate the ULTRAGAIN PRO. Blown fuses may only be replaced by fuses of the same type and rating.
- 13 *MAINS CONNECTION*. Use the enclosed power cord to connect the unit to the mains. Please also note the instructions given in the "INSTALLATION" chapter.
- 14 *AUDIO IN*. These are the audio inputs of your ULTRAGAIN PRO. The XLR connector is the common mic/line input. The line input is based on jack connection.
- 15 *AUDIO OUT*. These are the audio outputs of your ULTRAGAIN PRO. Matching phone jack and XLR connectors are wired in parallel.

5. APPLICATIONS

This section describes some typical applications of the BEHRINGER ULTRAGAIN PRO. Starting from the following basic settings you can use it to solve the majority of audio problems.

Please take your time to study the application examples, so as to be able to fully exploit the ULTRAGAIN PRO and its variety of features.

Basically, the ULTRAGAIN PRO can be used in five areas of application:

1. Using the ULTRAGAIN PRO as a high-quality microphone preamp.
2. Using the ULTRAGAIN PRO to convert home recording to studio levels, and vice versa.

3. Using the ULTRAGAIN PRO to balance unbalanced signals (DI box).
4. Using the ULTRAGAIN PRO as a parametric equalizer specifically “tweaking” the frequency response.
5. Using the ULTRAGAIN PRO to enhance the sound of the program material by adding “tube warmth”.

5.1 The ULTRAGAIN PRO as a microphone preamplifier

Before you can use the BEHRINGER ULTRAGAIN PRO as a preamp, we recommend that you study the various functions of the device. The high gain factors provided by the microphone preamp can produce extreme levels on the output side, which may damage subsequent devices. So, you should start with the following basic setting:

5.1.1 Basic setting

Control elements	position
+48 V switch	OUT
MIC GAIN control	10 dB
MIC/LINE switch	LINE
PHASE REV. Control	OUT
LO CUT switch	OUT
EQ IN/OUT switch	OUT
OUTPUT control	0 dB

Tab. 5.1: Basic setting of the ULTRAGAIN PRO

Reduce the volume level of the subsequent audio system to a minimum, and connect a microphone to the XLR input connector on the BEHRINGER ULTRAGAIN PRO. Use either the jack or XLR output connectors to connect the audio system. Owing to its output-side servo balancing circuit, the ULTRAGAIN PRO detects whether you use a balanced or unbalanced configuration and adjusts the level internally.

Now, power up the entire equipment and press the MIC/LINE switch to activate the microphone preamp. If you wish to use a condenser mic requiring +48 V phantom power, please press the +48 V switch (to avoid electrical damage, please read chapter 5.1.5 “+48 V switch” below).

5.1.2 MIC GAIN control

Configure the equipment according to the application on hand, speak into the microphone and turn the GAIN control clockwise until the 0 dB LED lights up. If your DAT recorder, mixing console or other subsequent devices have high-precision level meters, you can use these to verify the correct level setting.

The maximum output level depends on the device that follows next in the audio chain, and must therefore be set specifically. The high-precision level meter on the ULTRAGAIN PRO indicates the current operating level. The CLIP LED lights up at a level of +18 dBu signaling that you have an additional headroom of 5 dB available, before the microphone preamp starts overloading. If distortion/overloading occurs at high volume levels, you should reduce the gain with the MIC GAIN control.

5.1.3 PHASE REV. switch

The PHASE REV. switch reverses the audio signal’s phase by 180°. Usually, you won’t need this switch. However, in some cases, it might be necessary to reverse the signal phase, for example, if a microphone cable has been connected incorrectly (pins 2 and 3 interchanged), or if several microphones are used and specific circumstances with regard to room acoustics are causing problems (e.g. frequency cancellations are usually caused by phase problems). The phase reverse function will help you locate and eliminate any such problem.



5.1.4 LO CUT function

When you pick up acoustic signals with microphones, it is usually necessary to eliminate low-end signal portions, such as rumble or pop noise, or other interference frequencies. Often, such frequencies have very high amplitudes and do not only deteriorate the sound quality but can also damage the power amps or speakers. Your ULTRAGAIN PRO features a tunable high-pass filter with a very high slope. Press the LO CUT switch and adjust the FREQUENCY control, so that any disturbing frequencies are faded out as much as possible, with the least damage done to the actual audio signals. Press/release the LO CUT switch several times to make an A/B comparison.

5.1.5 Phantom power

Condenser microphones need a specific supply voltage polarizing the condenser diaphragm. This voltage can be furnished from an internal battery, or an external power supply that is either connected directly to the microphone or supplies the voltage through the microphone cable. In practice, this technique is usually referred to as +48 V or phantom power supply, and uses the microphone cable to carry both the audio signal and the supply voltage required for the microphone.

Please read this chapter thoroughly: phantom power can damage the microphone, if used improperly.

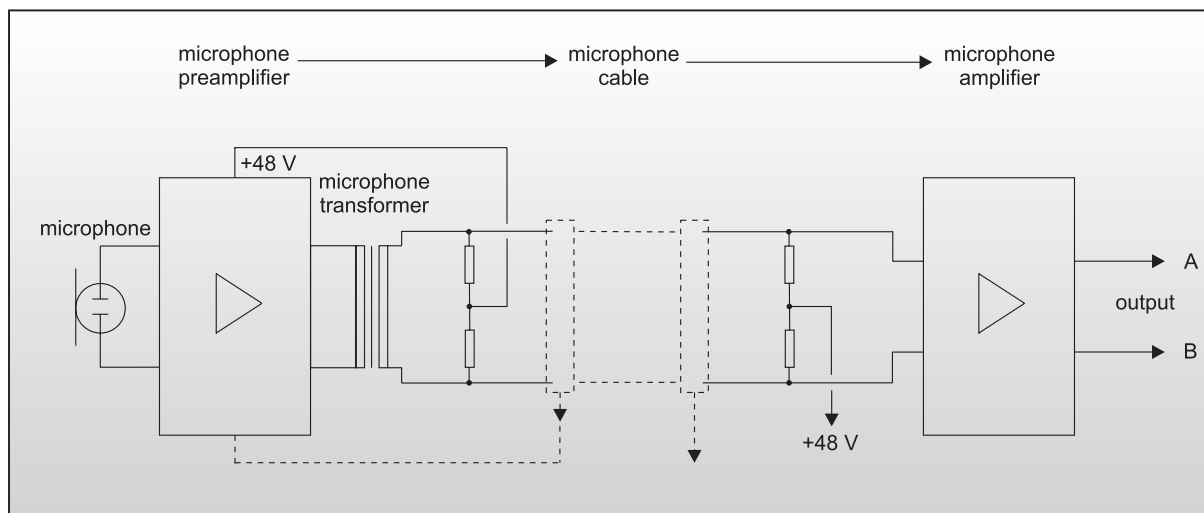

Fig. 5.1: Functional diagram of phantom power supply

We speak of phantom power when a microphone cable is used to carry several signals, with a DC voltage “layered” on the actual audio signal. The typical phantom DC voltage is +48 V, which is applied both to the positive (pin 2) and negative inputs (pin 3) of the XLR connector, using current-limiting resistors. As the phantom voltage is split up in a balanced configuration among the signal leads, there is no need to apply it directly to the microphone transducer or the microphone itself, where it could damage the transducer and/or capsule. In an unbalanced configuration, DC voltage would be applied directly, which would inevitably lead to disturbing noise or could even damage the electronics.

To eliminate this risk, the BEHRINGER ULTRAGAIN PRO automatically disables the unbalanced phone jack in MIC mode. Microphones can thus only be connected to the XLR connector.

Never switch on the +48 V supply when you use unbalanced microphones, as this could cause electrical damage.

Some people hold that the sound of dynamic microphones is affected when the +48 V supply is on, or that ribbon microphones cannot be operated from an input equipped with +48 V phantom power. None of these statements is true. As a matter of fact, problems of this kind are caused by one of the following reasons:

1. When the output transformer of the microphone suffers from a short circuit or leakage current at any point, disturbing noise, clicks or hum can occur. In this case, you should have the microphone repaired.
2. When you connect a microphone while the +48 V supply is switched on, it cannot be guaranteed that both signal leads of the XLR connectors establish the electrical contact precisely at the same point of time. Therefore, detrimental current could flow because the connection is temporarily unbalanced. We recommend that

you switch off the +48 V supply before you attempt to connect a microphone.

 **Please make sure that you are using an appropriate microphone before you switch on the +48 V supply. Read the operating instructions accompanying the microphone. Some condenser mics might need another type of power supply, older dynamic microphones could be damaged by the +48 V voltage, and unbalanced microphones should never be operated in combination with a +48 V power supply.**

5.2 The ULTRAGAIN PRO as a level translator

Semi-professional devices in hi-fi and home recording environments are usually operated with a nominal level of -10 dBV (0.316 V), while the level used in studios is 0 dBu (0.775 V) or +4 dBu (1.23 V). So, when you connect devices of both types to each other, you should do this via some kind of level translator.

The BEHRINGER ULTRAGAIN PRO is excellently suited for this application. In LINE mode, the OUTPUT control allows you to raise or lower the input signal level by as much as 20 dB. The functions PHASE REV. and LO CUT are also enabled in this mode.

5.3 The ULTRAGAIN PRO as a direct-injection box

When electrical signals delivered by instruments such as guitars, keyboards, etc. are transported over long unbalanced lines, the transmission quality may be affected by hum or other interference signals induced in the cable. This problem is usually encountered in studio or stage environments, where long cable lengths and magnetic fields of great magnitude may produce interference.

So-called direct-injection (DI) boxes are used to counter this effect: the DI box converts the unbalanced signal coming from the instrument into a balanced signal that is sent over the line. Interference induced in balanced cables is then eliminated by a subsequent differential amplifier (as explained in chapter 3.3).

Using the ULTRAGAIN PRO for this kind of application is easy. Simply connect the line output of your keyboard to the phone jack input on the ULTRAGAIN PRO. Then use the ULTRAGAIN PRO's balanced output to send the signal to a stage box or other transmission chain. You can use both the XLR and phone jack connectors of the ULTRAGAIN PRO. Set the unit to LINE mode, with any additional functions switched off (an exception being the OUTPUT control which can be used to adjust levels, if necessary).

5.4 The ULTRAGAIN PRO's parametric equalizer

In contrast to graphic equalizers with their fixed frequencies and qualities, parametric EQs allow for setting all filter parameters, such as center frequency, bandwidth and amplitude.

The possibility of determining both the bandwidth and center frequency as well as frequency boost/cut adds a new dimension to your EQ applications. The high precision of the state-variable filter used in the ULTRAGAIN PRO enables you to fine-tune frequencies and process your audio material in such a creative way that has been impossible up to now. The frequency-selection feature allows you to process the entire audio range from 20 Hz to 20 kHz.

Parametric equalizers can be used both as separate signal processors and in combination with conventional 1/3-oct. equalizers, for example, in a sound reinforcement system: while the 1/3-oct. equalizer does the "rough" correction of the overall frequency response, the ULTRAGAIN PRO could be used to fine-tune the sound.

"Notching out" specific interference frequencies and narrow-band resonances (uncontrolled frequency peaks) is one of the ULTRAGAIN PRO's major tasks: by tuning the EQ in to the precise trouble frequency, interference such as hum and noise caused by air conditioners, etc. can be eliminated without affecting adjacent frequency ranges. Basic acoustic problems usually encountered in studios and stage systems can be solved elegantly with the ULTRAGAIN PRO.

It has proven useful in practice to start with all controls set to mid-travel position and the EQ IN/OUT switch set to OUT, so as to avoid even before powering up the system that applied input signals with high amplitudes are raised in level by the ULTRAGAIN PRO and hence lead to distortion or damage in subsequent devices or speakers, or to annoying feedback in P.A. systems caused by improper basic settings.

Once the filter curve of your choice has been set, it can be necessary to correct the overall level. If the filter

setting used raises the overall level, you can use the OUTPUT control to lower it again and avoid possible distortion.

When the overall level is lowered by the filter setting, the OUTPUT control allows for raising it by a maximum amount of +20 dB. Use the EQ IN/OUT switch for a direct A/B comparison, so that you can estimate the required amount of level compensation.

5.5 The ULTRAGAIN PRO as a tube interface

In your daily studio work, the ULTRAGAIN PRO can be used for a variety of applications that provide subtle sound enhancement. For example, it gives percussion instruments more “punch”, or improves the transparency of other instruments, particularly those rich in upper harmonics. The source material is enriched in sound volume and brilliance. Enhanced “depth” makes it easier to locate individual instruments. Vocal sounds gain in presence and volume, without masking other instruments. Thus, voices become a more integral part of the overall mix. Synthetic sound, especially MIDI guitar sounds become more real and natural than without the ULTRAGAIN PRO. So, with the ULTRAGAIN PRO you can adopt a more active approach during the mix-down process and work out subtleties, while focusing particularly on the musical aspects of your recordings.

For this purpose, connect the device to the insert points on your mixing console or recording/playback machine, and operate the ULTRAGAIN PRO in LINE mode. If you wish to use the tube function only, make sure that all PHASE REV., LO CUT and EQ IN/OUT switches are OUT. Set the OUTPUT control to mid-travel position and enjoy the “warmth” of pure tube sound.

6. SPECIFICATIONS

AUDIO INPUT

Microphone

Connectors	XLR
Type	transformerless, DC-decoupled input
Impedance	3 k Ohms balanced
Maximum input level	+10 dBu balanced and unbalanced
CMRR	typ. 40 dB, >55 dB @ 1 kHz

Line

Connectors	XLR and 1/4" jack
Type	transformerless, DC-decoupled input
Impedance	60 kOhms balanced
Maximum input level	+23 dBu balanced and unbalanced
CMRR	typ. 40 dB, >55 dB @ 1kHz

AUDIO OUTPUT

Connectors	XLR and 1/4" jack
Type	electronically servo-balanced output stage
Impedance	60 Ohms balanced, 30 Ohm unbalanced
Maximum output level	+21 dBu balanced and unbalanced

SYSTEM SPECIFICATIONS

Frequency response	10 Hz to 200 kHz, +/- 3 dB
Noise	>94 dBu, unweighted, 22 Hz to 22 kHz
THD	0.011 % typ. @ +4 dBu, 1 kHz, Gain 1
IMD	0.01 % typ. SMPTE
Crosstalk	<-88 dB, 22 Hz to 22 kHz

FUNCTION CONTROLS

Mic gain	variable (+10 dB to +60 dB)
Frequency (lo cut)	variable (12 to 320 Hz)
Frequency (PEQ)	variable (10 Hz to 20 kHz), dependent on x 10 and x 0.1 switch
Bandwidth	variable (0.03 to 2 octaves)
Level	variable (-15 dB to +15 dB)
Output	variable (-20 dB to +20 dB)



FUNCTION SWITCHES

+48 V	activates phantom power
Mic/line	switches from line to mic preamplifier
Phase rev.	phase reverse (180°)
Lo cut	activates the high-pass filter
x 0.1	switches the frequency control to 10 Hz - 200 Hz
x 10	switches the frequency control to 1 kHz - 20 kHz
EQ in/out	activates the parametric filter

INDICATORS

Clip	clipping control LED
Output level	12-segment LED display: -30/-24/-18/-12/-6/-3/0/+3/+6/+9/+12/+18 dB
function switch	LED indicator of every switch

POWER SUPPLY

Mains voltages	USA/Canada	~ 120 V AC, 60 Hz
	U.K./Australia	~ 240 V AC, 50 Hz
	Europe	~ 230 V AC, 50 Hz
	General Export Model	~ 100-120 V AC, ~ 200-240 V AC, 50-60 Hz
Power consumption		10 Watts
Fuse		100-120 V AC: 500 mA (slow-blow) 200-240 V AC: 250 mA (slow-blow)
Mains connection		standard IEC receptacle

PHYSICAL

Dimension	1 3/4" (44.5 mm) * 19" (482.6 mm) * 8 1/2" (217 mm)
Net weight	3.0 kg
Shipping weight	4.2 kg

BEHRINGER is constantly striving to maintain the highest professional standards. As a result of these efforts, modifications may be made from time to time to existing products without prior notice. Specifications and appearance may differ from those listed or shown.

7. WARRANTY

§ 1 WARRANTY CARD

To be protected by this warranty, the buyer must complete and return the enclosed warranty card (signed/stamped by retail dealer) within 14 days of the date of purchase to BEHRINGER INTERNATIONAL (address see § 3). Failure to return the card in due time (date as per postmark) will void any extended warranty claims.

§ 2 WARRANTY

1. BEHRINGER INTERNATIONAL warrants the mechanical and electronic components of this product to be free of defects in material and workmanship for a period of one (1) year from the original date of purchase, in accordance with the warranty regulations described below. If any defects occur within the specified warranty period that are not caused by normal wear or inappropriate use, BEHRINGER INTERNATIONAL shall, at its sole discretion, either repair or replace the product.

2. If the warranty claim proves to be justified, the product will be returned freight prepaid by BEHRINGER INTERNATIONAL within Germany. Outside of Germany, the product will be returned at the buyer's expense.

3. Warranty claims other than those indicated above are expressly excluded.

§ 3 RETURN AUTHORIZATION NUMBER

1. To obtain warranty service, the buyer must call BEHRINGER INTERNATIONAL during normal business hours BEFORE returning the product (Tel.: +49 (0) 21 54 / 92 06 66). All inquiries must be accompanied by a description of the problem. BEHRINGER INTERNATIONAL will then issue a return authorization number.

2. The product must be returned in its original shipping carton, together with the return authorization number, to the following address:

BEHRINGER INTERNATIONAL GmbH
Service Department
Hanns-Martin-Schleyer-Str. 36-38
D - 47877 Willich-Münchheide

3. Shipments without freight prepaid will not be accepted.

§ 4 WARRANTY REGULATIONS

1. Warranty services will be furnished only if the product is accompanied by an original retail dealer's invoice. Any product deemed eligible for repair or replacement by BEHRINGER INTERNATIONAL under the terms of this warranty will be repaired or replaced within 30 days of receipt of the product at BEHRINGER INTERNATIONAL.

2. If the product needs to be modified or adapted in order to comply with applicable technical or safety standards on a national or local level, in any country which is not the country for which the product was originally developed and manufactured, this modification/adaptation shall not be considered a defect in materials or workman-

ship. The warranty does not cover any such modification/adaptation, irrespective of whether it was carried out properly or not. Under the terms of this warranty, BEHRINGER INTERNATIONAL shall not be held responsible for any cost resulting from such a modification/adaptation.

3. Free inspections, maintenance/repair work and replacement of parts are expressly excluded from this warranty, in particular if caused by inappropriate use. Likewise, the warranty does not cover defects of expendable parts caused by normal wear of the product. Expendable parts are typically faders, potentiometers, switches and similar components.

4. Damages/defects caused by the following conditions are not covered by this warranty:

- ▲ misuse, neglect or failure to operate the unit in compliance with the instructions given in the user or service manuals.
- ▲ connection or operation of the unit in any way that does not comply with the technical or safety regulations applicable in the country where the product is used.
- ▲ damages/defects that are caused by force majeure or by any other condition beyond the control of BEHRINGER INTERNATIONAL.

5. Any repair carried out by unauthorized personnel will void the warranty.

6. Products which do not meet the terms of this warranty will be repaired exclusively at the buyer's expense. BEHRINGER INTERNATIONAL will inform the buyer of any such circumstance. If the buyer fails to submit a written repair order within 4 weeks after notification, BEHRINGER INTERNATIONAL will return the unit C.O.D. with a separate invoice for freight and packing. Such cost will also be invoiced separately when the buyer has sent in a written repair order.

§ 5 WARRANTY TRANSFERABILITY

This warranty is extended exclusively to the original buyer (customer of retail dealer) and is not transferable to anyone who may subsequently purchase this product. No other person (retail dealer, etc.) shall be entitled to give any warranty promise on behalf of BEHRINGER INTERNATIONAL.

§ 6 CLAIM FOR DAMAGES

Failure of BEHRINGER INTERNATIONAL to provide proper warranty service shall not entitle the buyer to claim (consequential) damages. In no event shall the liability of BEHRINGER INTERNATIONAL exceed the invoiced value of the product.

§ 7 OTHER WARRANTY RIGHTS

This warranty does not exclude or limit the buyer's statutory rights provided by national law, in particular, any such rights against the seller that arise from a legally effective purchase contract.

The information contained in this manual is subject to change without notice. No part of this manual may be reproduced or transmitted in any form or by any means, electronic or mechanical, including photocopying and recording of any kind, for any purpose, without the express written permission of BEHRINGER GmbH.

BEHRINGER and ULTRAGAIN are registered trademarks. ALL RIGHTS RESERVED © 1999 BEHRINGER.
BEHRINGER INTERNATIONAL GmbH, Hanns-Martin-Schleyer-Str. 36-38, D-47877 Willich-Münchheide II
Tel. +49 (0) 21 54 / 92 06-0, Fax +49 (0) 21 54 / 92 06-30
