

KC-550 KC-350

STEREO MIXING KEYBOARD AMPLIFIER

OWNER'S MANUAL

Thank you, and congratulations on your choice of the Roland Keyboard Amplifier KC-550/KC-350.

These sections provide important information concerning the proper operation of the unit. Additionally, in order to feel assured that you have gained a good grasp of every feature provided by your new unit, Owner's manual should be read in its entirety. The manual should be saved and kept on hand as a convenient reference.

Before using this unit, carefully read the sections entitled:

- **IMPORTANT SAFETY INSTRUCTIONS (p. 2)**
- **USING THE UNIT SAFELY (p. 3–p. 4)**
- **IMPORTANT NOTES (p. 5)**



Main Features

- This monitor-speaker amplifier is designed to provide high-quality sound for a variety of sources, including digital keyboards and sound modules.
- The amps' two-way speaker systems consist of a 38 cm (15-inch) speaker (in the KC-550; the KC-350 includes a 30 cm [12-inch] speaker) and horn/tweeter. These amps feature high-power output as well, with the KC-550 outputting 180 watts and the KC-350 120 watts.
- The input section features a four-channel stereo mixer. CH 1 is provided with an XLR connector in addition to supporting mic input.
- CH 4 includes a select switch that lets you choose the destination for output. This feature rounds out the monitor functions.
- The KC-550/KC-350 is equipped with a three-band equalizer. Moreover, when combined with the SHAPE switch, even more tonal variations are possible.
- Features a SUBWOOFER OUT jack, allowing connection of a powered subwoofer for playback of even more impressive bass.
- Provided with an RCA phono type AUX IN jack, making it easy to connect devices such as CD and MD players.
- Equipped with line outs, making it convenient to connect to an external mixer or recorder.
- Equipped with STEREO LINK function. Stereo playback is enabled simply by connecting two KC-550 or KC-350 units with a single audio cable (phone type).

Copyright © 2003 ROLAND CORPORATION

All rights reserved. No part of this publication may be reproduced in any form without the written permission of ROLAND CORPORATION.

WARNING: To reduce the risk of fire or electric shock, do not expose this apparatus to rain or moisture.

	CAUTION RISK OF ELECTRIC SHOCK DO NOT OPEN	
ATTENTION: RISQUE DE CHOC ELECTRIQUE NE PAS OUVRIR		
CAUTION: TO REDUCE THE RISK OF ELECTRIC SHOCK, DO NOT REMOVE COVER (OR BACK). NO USER-SERVICEABLE PARTS INSIDE. REFER SERVICING TO QUALIFIED SERVICE PERSONNEL.		



The lightning flash with arrowhead symbol, within an equilateral triangle, is intended to alert the user to the presence of uninsulated "dangerous voltage" within the product's enclosure that may be of sufficient magnitude to constitute a risk of electric shock to persons.



The exclamation point within an equilateral triangle is intended to alert the user to the presence of important operating and maintenance (servicing) instructions in the literature accompanying the product.

INSTRUCTIONS PERTAINING TO A RISK OF FIRE, ELECTRIC SHOCK, OR INJURY TO PERSONS.

IMPORTANT SAFETY INSTRUCTIONS SAVE THESE INSTRUCTIONS

WARNING - When using electric products, basic precautions should always be followed, including the following:

1. Read these instructions.
2. Keep these instructions.
3. Heed all warnings.
4. Follow all instructions.
5. Do not use this apparatus near water.
6. Clean only with a dry cloth.
7. Do not block any of the ventilation openings. Install in accordance with the manufacturers instructions.
8. Do not install near any heat sources such as radiators, heat registers, stoves, or other apparatus (including amplifiers) that produce heat.
9. Do not defeat the safety purpose of the polarized or grounding-type plug. A polarized plug has two blades with one wider than the other. A grounding type plug has two blades and a third grounding prong. The wide blade or the third prong are provided for your safety. If the provided plug does not fit into your outlet, consult an electrician for replacement of the obsolete outlet.
10. Protect the power cord from being walked on or pinched particularly at plugs, convenience receptacles, and the point where they exit from the apparatus.
11. Only use attachments/accessories specified by the manufacturer.
12. Unplug this apparatus during lightning storms or when unused for long periods of time.
13. Refer all servicing to qualified service personnel. Servicing is required when the apparatus has been damaged in any way, such as power-supply cord or plug is damaged, liquid has been spilled or objects have fallen into the apparatus, the apparatus has been exposed to rain or moisture, does not operate normally, or has been dropped.

For the U.K.

WARNING: THIS APPARATUS MUST BE EARTHED

IMPORTANT: THE WIRES IN THIS MAINS LEAD ARE COLOURED IN ACCORDANCE WITH THE FOLLOWING CODE.
GREEN-AND-YELLOW: EARTH, BLUE: NEUTRAL, BROWN: LIVE

As the colours of the wires in the mains lead of this apparatus may not correspond with the coloured markings identifying the terminals in your plug, proceed as follows:

The wire which is coloured GREEN-AND-YELLOW must be connected to the terminal in the plug which is marked by the letter E or by the safety earth symbol  or coloured GREEN or GREEN-AND-YELLOW.

The wire which is coloured BLUE must be connected to the terminal which is marked with the letter N or coloured BLACK.

The wire which is coloured BROWN must be connected to the terminal which is marked with the letter L or coloured RED.

USING THE UNIT SAFELY

INSTRUCTIONS FOR THE PREVENTION OF FIRE, ELECTRIC SHOCK, OR INJURY TO PERSONS

About ⚠ WARNING and ⚠ CAUTION Notices

⚠ WARNING	Used for instructions intended to alert the user to the risk of death or severe injury should the unit be used improperly.
⚠ CAUTION	Used for instructions intended to alert the user to the risk of injury or material damage should the unit be used improperly. * Material damage refers to damage or other adverse effects caused with respect to the home and all its furnishings, as well to domestic animals or pets.

About the Symbols

	The ⚠ symbol alerts the user to important instructions or warnings. The specific meaning of the symbol is determined by the design contained within the triangle. In the case of the symbol at left, it is used for general cautions, warnings, or alerts to danger.
	The ⓧ symbol alerts the user to items that must never be carried out (are forbidden). The specific thing that must not be done is indicated by the design contained within the circle. In the case of the symbol at left, it means that the unit must never be disassembled.
	The ⚡ symbol alerts the user to things that must be carried out. The specific thing that must be done is indicated by the design contained within the circle. In the case of the symbol at left, it means that the power-cord plug must be unplugged from the outlet.

ALWAYS OBSERVE THE FOLLOWING

⚠ WARNING

- Before using this unit, make sure to read the instructions below, and the Owner's Manual.

- Connect mains plug of this model to a mains socket outlet with a protective earthing connection.

- Do not attempt to repair the unit, or replace parts within it (except when this manual provides specific instructions directing you to do so). Refer all servicing to your retailer, the nearest Roland Service Center, or an authorized Roland distributor, as listed on the "Information" page.

- Never use or store the unit in places that are:
 - Subject to temperature extremes (e.g., direct sunlight in an enclosed vehicle, near a heating duct, on top of heat-generating equipment); or are
 - Damp (e.g., baths, washrooms, on wet floors); or are
 - Humid; or are
 - Exposed to rain; or are
 - Dusty; or are
 - Subject to high levels of vibration.

- Make sure you always have the unit placed so it is level and sure to remain stable. Never place it on stands that could wobble, or on inclined surfaces.

- The unit should be connected to a power supply only of the type described in the operating instructions, or as marked on the unit.

⚠ WARNING





- Do not excessively twist or bend the power cord, nor place heavy objects on it. Doing so can damage the cord, producing severed elements and short circuits. Damaged cords are fire and shock hazards!

- This unit, either alone or in combination with an amplifier and headphones or speakers, may be capable of producing sound levels that could cause permanent hearing loss. Do not operate for a long period of time at a high volume level, or at a level that is uncomfortable. If you experience any hearing loss or ringing in the ears, you should immediately stop using the unit, and consult an audiologist.











- Do not allow any objects (e.g., flammable material, coins, pins); or liquids of any kind (water, soft drinks, etc.) to penetrate the unit.

- Immediately turn the power off, remove the power cord from the outlet, and request servicing by your retailer, the nearest Roland Service Center, or an authorized Roland distributor, as listed on the "Information" page when:
 - The power-supply cord, or the plug has been damaged; or
 - If smoke or unusual odor occurs
 - Objects have fallen into, or liquid has been spilled onto the unit; or
 - The unit has been exposed to rain (or otherwise has become wet); or
 - The unit does not appear to operate normally or exhibits a marked change in performance.

⚠ WARNING

- In households with small children, an adult should provide supervision until the child is capable of following all the rules essential for the safe operation of the unit. 
- Protect the unit from strong impact. (Do not drop it!) 
- Do not force the unit's power-supply cord to share an outlet with an unreasonable number of other devices. Be especially careful when using extension cords—the total power used by all devices you have connected to the extension cord's outlet must never exceed the power rating (watts/amperes) for the extension cord. Excessive loads can cause the insulation on the cord to heat up and eventually melt through. 
- Before using the unit in a foreign country, consult with your retailer, the nearest Roland Service Center, or an authorized Roland distributor, as listed on the "Information" page. 
- Do not put anything that contains water (e.g., flower vases) on this unit. Also, avoid the use of insecticides, perfumes, alcohol, nail polish, spray cans, etc., near the unit. Swiftly wipe away any liquid that spills on the unit using a dry, soft cloth. 

⚠ CAUTION

- The unit should be located so that its location or position does not interfere with its proper ventilation. 
 - Always grasp only the plug on the power-supply cord when plugging into, or unplugging from an outlet. 
 - At regular intervals, you should unplug the power plug and clean it by using a dry cloth to wipe all dust and other accumulations away from its prongs. Also, disconnect the power plug from the power outlet whenever the unit is to remain unused for an extended period of time. Any accumulation of dust between the power plug and the power outlet can result in poor insulation and lead to fire. 
 - Try to prevent cords and cables from becoming entangled. Also, all cords and cables should be placed so they are out of the reach of children. 
- KC-550**
- If the unit could become a hazard if it moves, all caster wheels should be removed once the unit has been placed at the place of installation, or has been loaded onto a vehicle. 
 - Never climb on top of, nor place heavy objects on the unit. 
 - Never handle the power cord or its plug with wet hands when plugging into, or unplugging from, an outlet. 
 - Before moving the unit, disconnect the power plug from the outlet, and pull out all cords from external devices. 
 - Before cleaning the unit, turn off the power and unplug the power cord from the outlet. 
 - Whenever you suspect the possibility of lightning in your area, pull the plug on the power cord out of the outlet. 
 - Do not remove the speaker grille and speaker by any means. Speaker not user replaceable. Shock hazardous voltages and currents are present inside the enclosure. 

IMPORTANT NOTES

In addition to the items listed under “IMPORTANT SAFETY INSTRUCTIONS” and “USING THE UNIT SAFELY” on pages 2, 3 and 4, please read and observe the following:

Power Supply

- Do not connect this unit to same electrical outlet that is being used by an electrical appliance that is controlled by an inverter (such as a refrigerator, washing machine, microwave oven, or air conditioner), or that contains a motor. Depending on the way in which the electrical appliance is used, power supply noise may cause this unit to malfunction or may produce audible noise. If it is not practical to use a separate electrical outlet, connect a power supply noise filter between this unit and the electrical outlet.
- Before connecting this unit to other devices, turn off the power to all units. This will help prevent malfunctions and/or damage to speakers or other devices.
- Although the LEDs are switched off when the POWER switch is switched off, this does not mean that the unit has been completely disconnected from the source of power. If you need to turn off the power completely, first turn off the POWER switch, then unplug the power cord from the power outlet. For this reason, the outlet into which you choose to connect the power cord's plug should be one that is within easy reach and readily accessible.

Placement

- Using the unit near power amplifiers (or other equipment containing large power transformers) may induce hum. To alleviate the problem, change the orientation of this unit; or move it farther away from the source of interference.
- This device may interfere with radio and television reception. Do not use this device in the vicinity of such receivers.
- Noise may be produced if wireless communications devices, such as cell phones, are operated in the vicinity of this unit. Such noise could occur when receiving or initiating a call, or while conversing. Should you experience such problems, you should relocate such wireless devices so they are at a greater distance from this unit, or switch them off.
- Do not expose the unit to direct sunlight, place it near devices that radiate heat, leave it inside an enclosed vehicle, or otherwise subject it to temperature extremes. Also, do not allow lighting devices that normally are used while their light source is very close to the unit (such as a piano light), or powerful spotlights to shine upon the same area of the unit for extended periods of time. Excessive heat can deform or discolor the unit.
- When moved from one location to another where the temperature and/or humidity is very different, water droplets (condensation) may form inside the unit. Damage or malfunction may result if you attempt to use the unit in this condition. Therefore, before using the unit, you must allow it to stand for several hours, until the condensation has completely evaporated.
- Do not allow rubber, vinyl, or similar materials to remain on the unit for long periods of time. Such objects can discolor or otherwise harmfully affect the finish.
- Do not paste stickers, decals, or the like to this instrument. Peeling such matter off the instrument may damage the exterior finish.
- Do not allow objects to remain on top of the unit while it is in operation.

Maintenance

- For everyday cleaning wipe the unit with a soft, dry cloth or one that has been slightly dampened with water. To remove stubborn dirt, use a cloth impregnated with a mild, non-abrasive detergent. Afterwards, be sure to wipe the unit thoroughly with a soft, dry cloth.
- Never use benzine, thinners, alcohol or solvents of any kind, to avoid the possibility of discoloration and/or deformation.
- For routine care of the carpeted surfaces, use a brush with stiff bristles.

Additional Precautions

- Use a reasonable amount of care when using the unit's buttons, sliders, or other controls; and when using its jacks and connectors. Rough handling can lead to malfunctions.
- When connecting / disconnecting all cables, grasp the connector itself—never pull on the cable. This way you will avoid causing shorts, or damage to the cable's internal elements.
- A small amount of heat will radiate from the unit during normal operation.
- To avoid disturbing your neighbors, try to keep the unit's volume at reasonable levels. You may prefer to use headphones, so you do not need to be concerned about those around you (especially when it is late at night).
- When you need to transport the unit, package it in the box (including padding) that it came in, if possible. Otherwise, you will need to use equivalent packaging materials.
- Use a cable from Roland to make the connection. If using some other make of connection cable, please note the following precautions.
 - Some connection cables contain resistors. Do not use cables that incorporate resistors for connecting to this unit. The use of such cables can cause the sound level to be extremely low, or impossible to hear. For information on cable specifications, contact the manufacturer of the cable.
- When transporting and storing the KC-550/KC-350, be sure to secure the AC cord to the cord hook on the rear of the main unit.

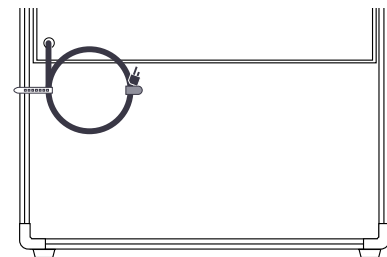

Panel Descriptions

Control Section

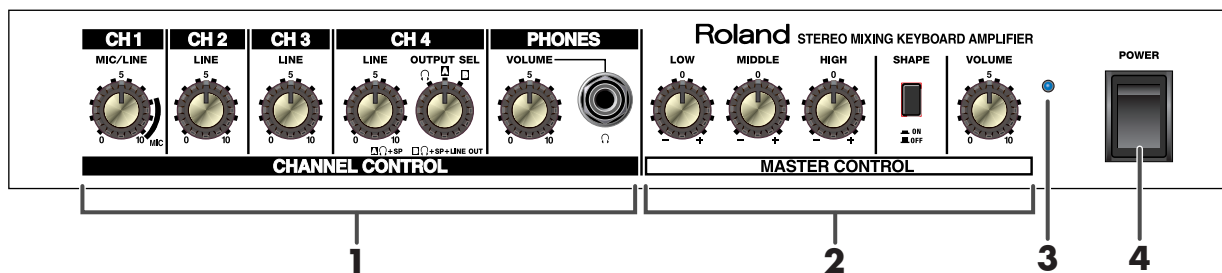

1. CHANNEL CONTROL

Stereo 4-channel mixing is offered by the **CHANNEL CONTROLS**.

* When using in “Stereo Link” configuration, refer to “Stereo Link” (p. 12).

CH 1, CH 2, CH 3

These adjust the volume levels for **CH 1**, **CH 2** and **CH 3**. **CH 1** accepts the mic input.

CH 4

This adjusts the volume level for **CH 4**.

CH 4 includes a select switch that lets you choose the destination for output.

OUTPUT SEL (output select) Switch

This switch selects the combination of outputs—headphones, speakers, and line outs—to which signals input to **CH 4** are sent.

A +SP

Output is through the headphones and the internal speakers. No signals are output to Line Out.



Output is only through the headphones. No signals are output to the internal speakers and Line Out.

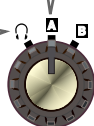

B +SP +LINE OUT

Output is through the headphones, the internal speakers, and Line Out.

* The **OUTPUT SEL** switch is convenient in situations like the following.



: Select this position when you wish to listen to guide clicks or a rhythm machine (for example) through headphones, without output to the internal or any external speakers.



: This can be a handy function when you want to use the amplifier as a fold back monitor during a live performance.

This is effective in preventing the loop noise that may occur at times such as when the **CH 4** input and Line Out on the KC-550/KC-350 are both connected to a mixer.



: Use **CH 4** equally with **CH 1** through **CH 3**.

PHONES

PHONES VOLUME Knob

This knob adjusts the headphone volume.

* The **PHONES VOLUME** knob affects only the headphone output.

PHONES Jack

This is for connecting headphones.

* The amplifier’s speakers work even when headphones are connected.

* Before plugging in or unplugging headphones, be sure to place the **PHONES VOLUME** knob at 0.

* The **MASTER CONTROL** (Equalizer, **SHAPE** switch and **VOLUME** knob) do not affect the headphone output.

2. MASTER CONTROL

EQUALIZER

The KC-550/KC-350 comes with a three-band equalizer.

LOW Knob

This adjusts the tone of the bass range.

MIDDLE Knob

This adjusts the tone of the middle range.

HIGH Knob

This adjusts the tone of the treble range.

- * *The equalizer (controlled with the **LOW**, **MIDDLE**, and **HIGH** knobs) affects only the output from **SUBWOOFER OUT** and the speakers.*

SHAPE Switch

When switched on, this provides a boost in the upper and lower ranges.

It can be conveniently used to improve the sound quality at low volumes, or to give the sound a greater sense of clarity.

- * *The **SHAPE** switch affects only the output from the speakers.*

VOLUME Knob

This adjusts the total volume level of the unit's internal speaker. The **SUBWOOFER OUT** output is also changed.

- * *The **VOLUME** knob do not affect the line outs.*

3. POWER Indicator

This indicator lights when the unit is turned on.

4. POWER Switch

This switches the power on and off.

- * *If you need to turn off the power completely, first turn off the **POWER** switch, then unplug the power cord from the power outlet. Refer to "Power Supply" (p. 5).*
- * *Before turning the power on or off, be sure to put the **VOLUME** knob at 0.*
- * *This unit is equipped with a protection circuit. A brief interval (a few seconds) after power up is required before the unit will operate normally.*
- * *Refer to p. 11 for the order in which to turn the power to connected devices on and off.*

Jack Panel

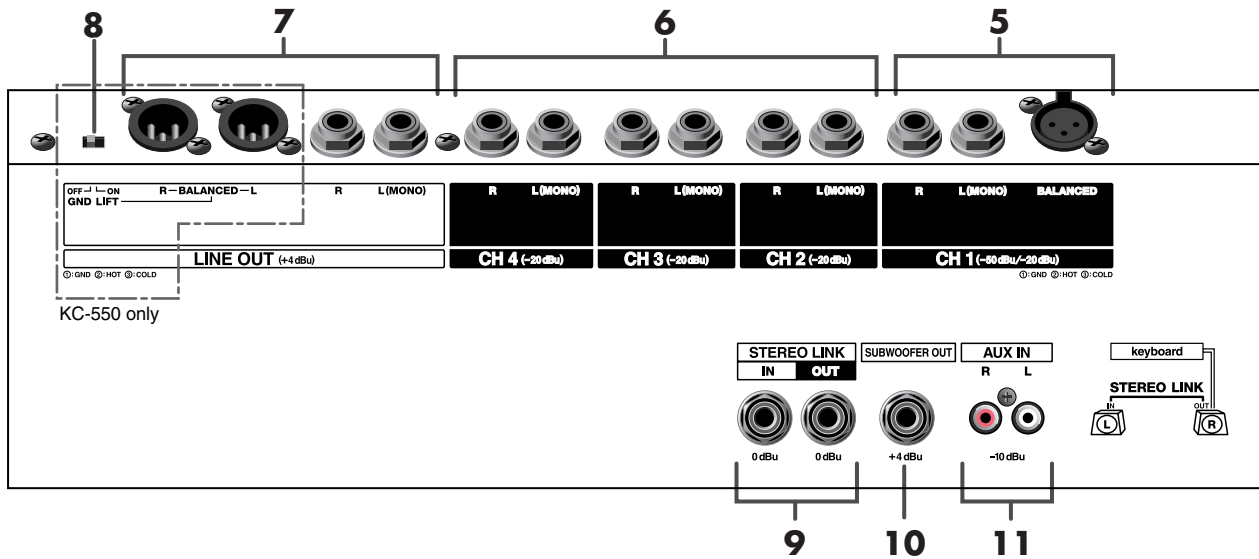

CHANNEL INPUT

5. CH 1 Input Jacks

In addition to a standard jack, this channel is equipped with a balanced XLR connector, useful for connecting mics. Use this for connecting mics, keyboards, sound modules, and other devices. Input levels ranging from mic input (-50 dBu) to line level (-20 dBu) are accepted.

6. CH 2, CH 3 and CH 4 Input Jacks

Use these for connecting keyboards, sound modules, and other devices. They accept line level input (-20 dBu). You can select the output for signals input to **CH 4** (p. 6).

7. LINE OUT

LINE OUT Jacks

(XLR-type connectors are featured only on the KC-550)

Connect a mixer or recording device to either (or both) of these pairs of outputs. There are two types of connectors: an XLR type and an unbalanced TRS 1/4" phone jack on the KC-550. The TRS 1/4" phone jack are unbalanced type. Use the one appropriate for the equipment you're connecting. This output jack provides +4 dBu line level output.

If you're making a mono connection, connect to the L (MONO) phone jack.

* **MASTER CONTROL** (equalizer, **SHAPE** switch and **VOLUME** knob) do not affect **LINE OUT**.

8. GND LIFT Switch (KC-550 only)

This selects whether the XLR-type **LINE OUT** jacks are grounded or not.

If you encounter noise problems that are possibly caused by a ground loop, try changing the switch position to alleviate the problem.

9. STEREO LINK

Stereo playback is enabled simply by connecting two KC-550 or KC-350 units with a single audio cable (phone type).

* *For details on the Stereo Link function, refer to "Stereo Link" (p. 12).*

STEREO LINK OUT Jack

Connect this jack to the **STEREO LINK IN** jack on a sub (L) KC-550/KC-350 when using a Stereo Link configuration.

This output jack provides 0 dBu line level output.

When a cable is connected to the **STEREO LINK OUT** jack, the right-channel input signals are output from the internal speakers. The left-channel input signals are output from the **STEREO LINK OUT** jack to the other KC-550/KC-350.

STEREO LINK IN Jack

Connect this jack to the **STEREO LINK OUT** jack on the main (R) unit (the other KC-550/KC-350) when using a Stereo Link configuration.

This accepts level input of 0 dBu.

Only the **STEREO LINK IN** input signals are output from the internal speakers.

10. SUBWOOFER OUT Jack

This lets you play even more powerful bass by connecting a powered subwoofer.

Provides full-range output, at an output level of +4 dBu.

You can use the **MASTER CONTROL** knobs (**LOW**, **MIDDLE**, **HIGH**, and **VOLUME**) to adjust the tone and volume level.

* **SHAPE** switch do not affect **SUBWOOFER OUT**.

11. AUX IN Jacks

These are RCA phono type input jacks.

You use these to connect equipment such as CD and MD players, and have them sound along with the equipment connected to **CH 1** through **CH 4**.

They accept level input of -10 dBu.

* *To adjust the volume level of equipment connected to the **AUX IN** jacks, use the controls on such equipment.*

Connect your KC-550/KC-350

Refer to the following diagram and connect the KC-550/KC-350 to the external equipment you are using.

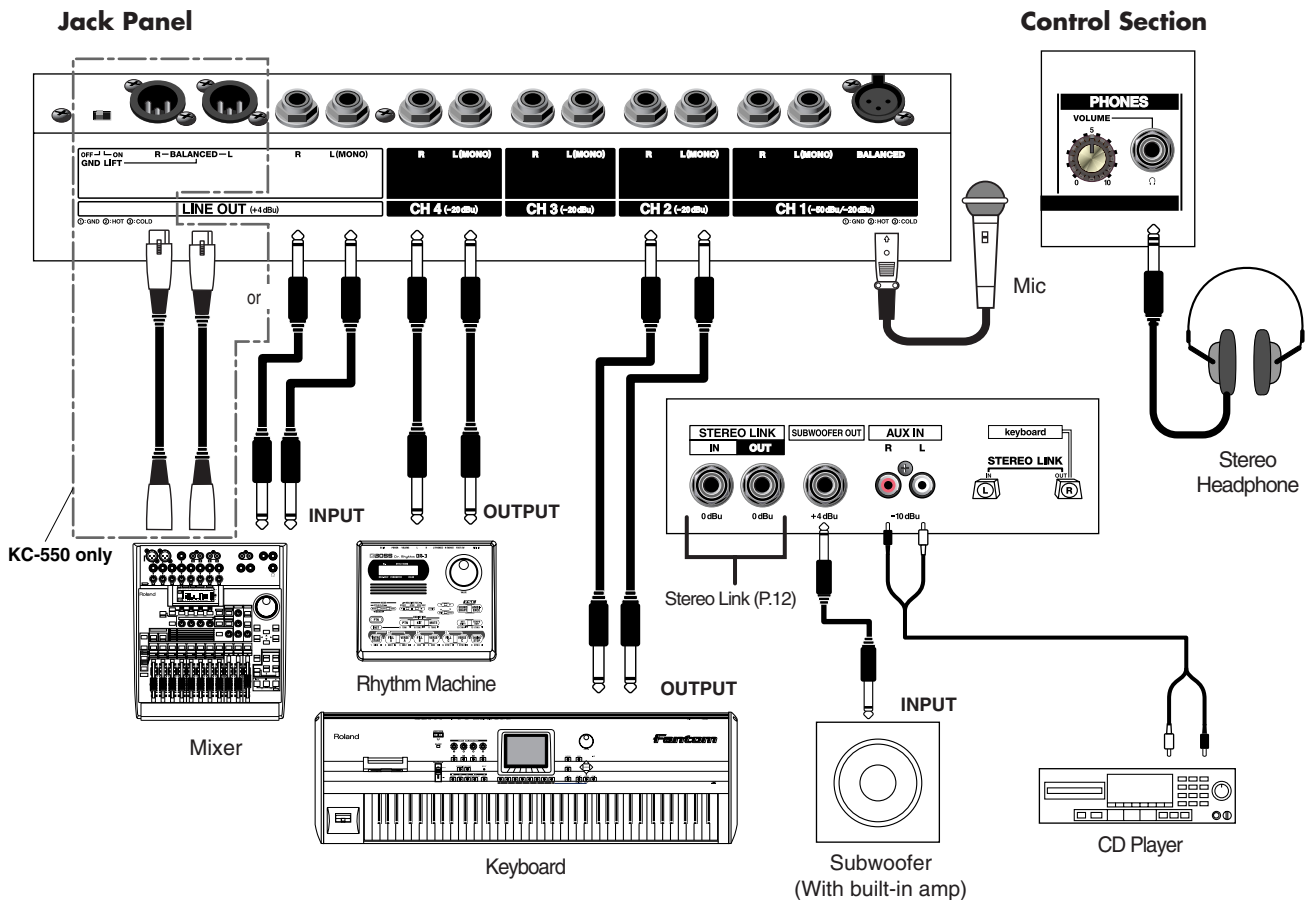

Here is an example of a setup that makes full use of the KC-550/KC-350's mixer and monitor functions.

A mic is input to **CH 1**, which accepts mic level input. Connect a keyboard, recorder, or other sound-generating device to the **CH 2**, **CH 3** and **CH 4** inputs.

The KC-550's line outputs include both XLR-type and 1/4" phone connectors. Furthermore, both types can be used simultaneously.

- * To prevent malfunction and/or damage to speakers or other devices, always turn down the volume, and turn off the power on all devices before making any connections. Set all of the KC-550/KC-350's channel volume knobs (**CH 1**, **CH 2**, **CH 3** and **CH 4**) as well as the **VOLUME** knob to zero.

- * The pin assignment for the XLR type connectors is as shown below. Before making any connections, make sure that this pin assignment is compatible with that of all your other devices.

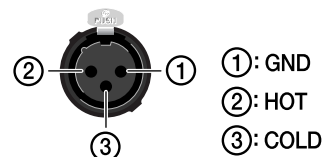

- * When connection cables with resistors are used, the volume level of equipment connected to the inputs (**CH 1** through **CH 4**, **AUX IN** and **STEREO LINK IN**) may be low. If this happens, use connection cables that do not contain resistors, such as those from the Roland PCS series.
- * Howling could be produced depending on the location of microphones relative to speakers. This can be remedied by:
 1. Changing the orientation of the microphone.
 2. Relocating microphone at a greater distance from speakers.
 3. Lowering volume levels.

Switching the Power On and Off

Once the connections have been completed, turn on power to your various devices in the order specified. By turning on devices in the wrong order, you risk causing malfunction and/or damage to speakers and other devices.

* Before switching off the power, lower the volume on each of the devices in your system and then **TURN OFF** the devices in the reverse order to which they were switched on.

1. Make sure that all volume controls on the KC-550/KC-350 and connected devices are set to 0.
2. Turn on all the devices connected to the KC-550/KC-350's input jacks (**CH 1** through **CH 4** and **AUX IN**).
3. Turn on the KC-550/KC-350.
4. Switch on any equipment connected to the KC-550/KC-350's **LINE OUT** or **SUBWOOFER OUT** jacks.
5. Adjust the volume levels for the devices.

* This unit is equipped with a protection circuit. A brief interval (a few seconds) after power up is required before the unit will operate normally. For protection from sudden big sound, always make sure to have the volume level turned down before switching on power. Even with the volume all the way down, you may still hear some sound when the power is switched on, but this is normal, and does not indicate a malfunction.

* If you need to turn off the power completely, first turn off the **POWER** switch, then unplug the power cord from the power outlet. Refer to "Power Supply" (p. 5).

About the Volume-level Settings

In order to get optimum sound from the KC-550/KC-350 when performing, set the volume as described below.

1. Operate the **CH 1** through **CH 4** volume knobs to adjust the volume level for **CH 1** through **CH 4**.

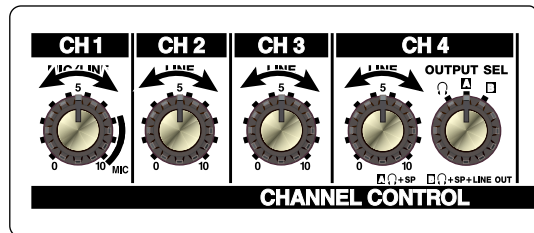

Adjust the volume balance for **CH 1** through **CH 4** at this time.

- * To adjust the volume level of equipment connected to the **AUX IN** jacks, use the controls on such equipment.
2. Adjust the **LOW**, **MIDDLE** and **HIGH** knobs to obtain the sound quality you want.
 3. Use the **VOLUME** knob to adjust the overall volume level.

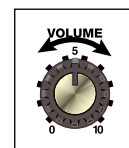

- * If the sound is distorted, lower the **CH 1** through **CH 4** volume knobs, **VOLUME** knob and/or the volume knobs for devices connected to the input jacks (**CH 1** through **CH 4** and **AUX IN**).

Stereo Link

Stereo playback is enabled simply by connecting two KC-550 or KC-350 units with a single audio cable (phone type).

This function is called "Stereo Link." As the channel control section is designed to accept stereo signals, connection of sound sources is needed only at the main unit, thus enabling channel volumes to be centrally controlled on the main unit.

The right-channel signals are output from the speakers in the main unit, while the left-channel signals are output from the speakers in the sub unit (the other KC-550/KC-350).

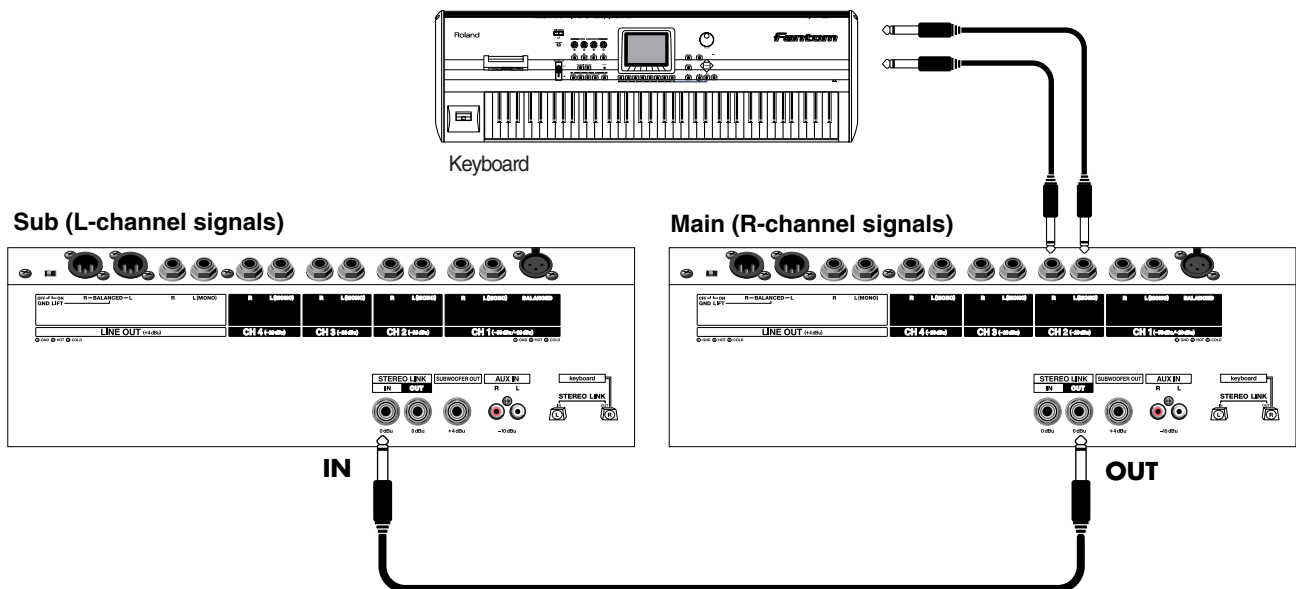

Connections

When using a Stereo Link configuration, connect all peripheral equipment to the main unit. Do not connect to any input/output jacks on the sub unit other than **STEREO LINK IN**.

* Before making the connections, be sure that the volume setting of the **VOLUME** knob for both amplifiers is set to "0."

Switching the power on or off

Once the connections have been completed, turn on power to your various devices in the order specified. By turning on devices in the wrong order, you risk causing malfunction and/or damage to speakers and other devices.

1. Turn on the devices connected to **CH 1** through **CH 4**.
2. Turn on the main KC-550/KC-350 amplifier.
3. Turn on the sub KC-550/KC-350 amplifier.
4. Turn on the devices connected to **LINE OUT** or **SUBWOOFER OUT**.
5. Adjust the volume levels on all devices.

Before switching off the power, lower the volume on each of the devices in your system, then **TURN OFF** the devices in the reverse order of that used when switching them on.

About the Volume and Tone Settings

Adjust the Main (R) and Sub (L) volume levels separately using their **VOLUME** knobs.

* You can make each unit's equalizer (**LOW**, **MIDDLE** and **HIGH** knobs), **SHAPE** switch, **VOLUME** knob, and **MAIN (R)** and **SUB (L)** settings independently.

Basically, they should be set to the same positions, but you can adjust each one as necessary to suit the needs of a particular setup.

Proper Use of the Casters

The KC-550 is equipped with casters, which make it easier to transport.

Attaching and Removing the Casters

You can attach or remove the casters as shown in the following figure.

- ! Be sure to remove all the casters when accidental movement may be dangerous, such as when setting up the KC-550/KC-350 on stage, or when transporting it in a vehicle.
- ! This is a heavy piece of equipment. To prevent injury caused by the unit overturning or being dropped, two or more people should work together when carrying the unit.
- ! If casters have been attached to the amp, make sure it is used only on a stable, level surface.

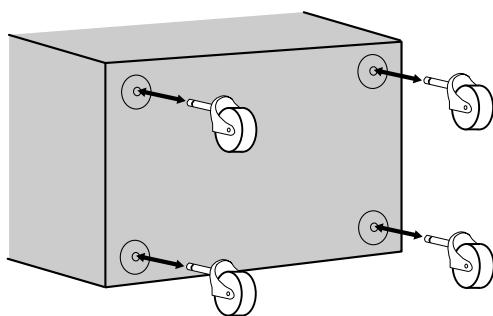

Block Diagram

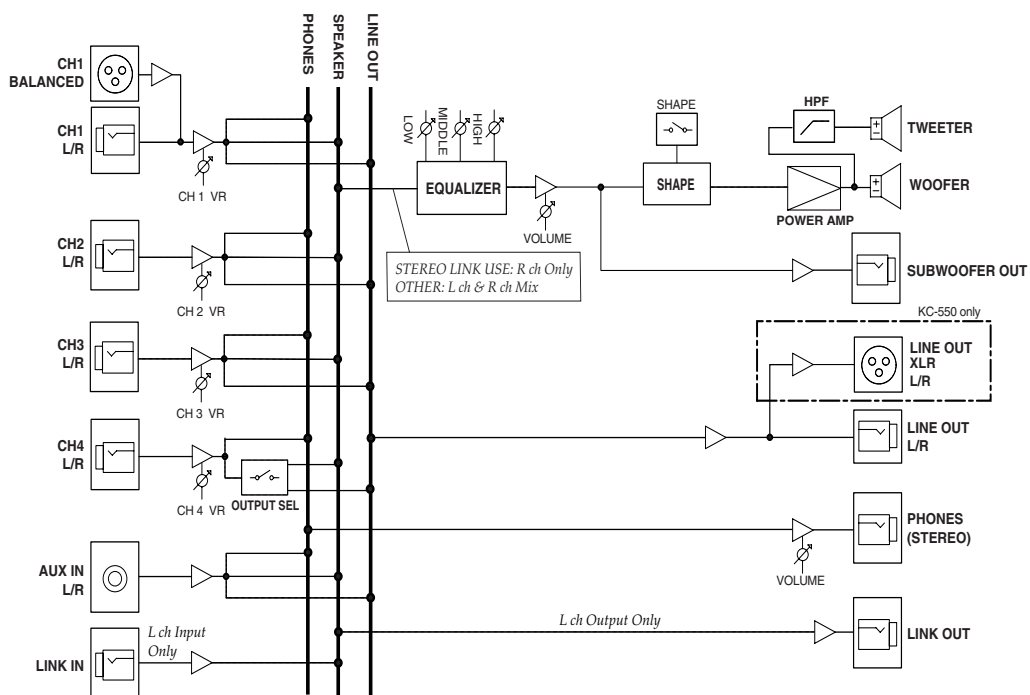

Main Specifications

KC-550: STEREO MIXING KEYBOARD AMPLIFIER SPECIFICATIONS

Rated Power Output

180 W

Nominal Input Level (1 kHz)

Channel 1 (MIC/LINE): -50 – -20 dBu
Channel 2–4 (LINE): -20 dBu
STEREO LINK INPUT: 0 dBu
AUX IN: -10 dBu

Nominal Output Level (1 kHz)

LINE OUT (XLR type, Phone type): +4 dBu
STEREO LINK OUTPUT: 0 dBu
SUBWOOFER OUT: +4 dBu

* 0 dBu = 0.775 Vrms

Speakers

38 cm (15 inches) x 1
Tweeter x 1

Controls

CHANNEL CONTROL

CH 1

VOLUME Knob

CH 2

VOLUME Knob

CH 3

VOLUME Knob

CH 4

VOLUME Knob

OUTPUT SELECT Switch

PHONES VOLUME Knob

MASTER CONTROL

EQUALIZER

LOW Knob

MIDDLE Knob

HIGH Knob

SHAPE Switch

VOLUME Knob

POWER Switch

GND LIFT Switch

Indicator

POWER

Connectors

CH 1 INPUT Jack (XLR type)
CH 1–4 INPUT L (MONO) Jacks (1/4" phone type)
CH 1–4 INPUT R Jacks (1/4" phone type)
LINE OUT L (MONO) Jacks (XLR type, 1/4" phone type)
LINE OUT R Jacks (XLR type, 1/4" phone type)
AUX IN Jacks (RCA phono type)
SUBWOOFER OUT Jack (1/4" phone type)
STEREO LINK OUT Jack (1/4" phone type)
STEREO LINK IN Jack (1/4" phone type)
PHONES Jack (Stereo 1/4" phone type)

Power Supply

AC 117 V, AC 230 V, AC 240 V

Power Consumption

135 W

Dimensions

590 (W) x 445 (D) x 590 (H) mm

23-1/4 (W) x 17-9/16 (D) x 23-1/4 (H) inches (including casters)

590 (W) x 445 (D) x 536 (H) mm

20-1/4 (W) x 21-5/16 (D) x 21-1/8 (H) inches (excluding casters)

Weight

29.0 kg

63 lbs 15 oz

Accessory

Owner's Manual

Casters

* In the interest of product improvement, the specifications and/or appearance of this unit are subject to change without prior notice.

KC-350: STEREO MIXING KEYBOARD AMPLIFIER SPECIFICATIONS

Rated Power Output

120 W

Nominal Input Level (1 kHz)

Channel 1 (MIC/LINE): -50– -20 dBu
 Channel 2–4 (LINE): -20 dBu
 STEREO LINK INPUT: 0 dBu
 AUX IN: -10 dBu

Nominal Output Level (1 kHz)

LINE OUT (Phone type): +4 dBu
 STEREO LINK OUTPUT: 0 dBu
 SUBWOOFER OUT: +4 dBu

* 0 dBu = 0.775 Vrms

Speakers

30 cm (12 inches) x 1
 Tweeter x 1

Controls

CHANNEL CONTROL

CH1

VOLUME Knob

CH2

VOLUME Knob

CH3

VOLUME Knob

CH4

VOLUME Knob

OUTPUT SELECT Switch

PHONES VOLUME Knob

MASTER CONTROL

EQUALIZER

LOW Knob

MIDDLE Knob

HIGH Knob

SHAPE Switch

VOLUME Knob

POWER Switch

Indicator

POWER

Connectors

CH 1 INPUT Jack (XLR type)
 CH 1–4 INPUT L (MONO) Jacks (1/4" phone type)
 CH 1–4 INPUT R Jacks (1/4" phone type)
 LINE OUT L (MONO) Jack (1/4" phone type)
 LINE OUT R Jack (1/4" phone type)
 AUX IN Jacks (RCA phono type)
 SUBWOOFER OUT Jack (1/4" phone type)
 STEREO LINK OUT Jack (1/4" phone type)
 STEREO LINK IN Jack (1/4" phone type)
 PHONES Jack (Stereo 1/4" phone type)

Power Supply

AC 117 V, AC 230 V, AC 240 V

Power Consumption

100 W

Dimensions

490 (W) x 385 (D) x 470 (H) mm
 19-5/16 (W) x 15-3/16 (D) x 18-9/16 (H) inches

Weight

22.0 kg
 48 lbs 9 oz

Accessory

Owner's Manual

* In the interest of product improvement, the specifications and/or appearance of this unit are subject to change without prior notice.

For EU Countries



This product complies with the requirements of European Directives EMC 89/336/EEC and LVD 73/23/EEC.