

# CA30D

## Acoustic Amplifier



**User's Guide**



# CA30D Acoustic Amplifier

## Table of Contents:

**Introduction**..... 3

**The Front Panel**..... 4



**Connecting to the Insert jack** ..... 5

**“Chaining” Amplifiers**..... 5

**The DSP Section** ..... 6

**System Block Diagram**..... 7

**Technical Specifications** ..... back cover

	<b>CAUTION</b> RISK OF ELECTRIC SHOCK DO NOT OPEN	
<small>WARNING: TO REDUCE THE RISK OF FIRE OR ELECTRIC SHOCK, DO NOT EXPOSE THIS APPARATUS TO RAIN OR MOISTURE. TO REDUCE THE RISK OF ELECTRIC SHOCK, DO NOT REMOVE COVER. NO USER-SERVICEABLE PARTS INSIDE. REFER SERVICING TO QUALIFIED SERVICE PERSONNEL.</small>		

	<b>PRECAUCION</b> RIESGO DE CORRIENTAZO NO ABRA	
<small>PRECAUCION: PARA REDUCIR EL RIESGO DE INCENDIOS O DESCARGAS ELECTRICAS, NO PERMITA QUE ESTE APARATO QUEDA EXPUESTO A LA LLUVIA O LA HUMEDAD. PARA DISMINUIR EL RIESGO DE CORRIENTAZO, NO ABRA LA CUBIERTA. NO HAY PIEZAS ADETRON QUE EL USARIO PUEDA REPARAR DEJE TODO MANTENIMIENTO A LOS TECNICOS CALIFICADOS.</small>		

	<b>ATTENTION</b> RISQUE D'ELECTROCUTION NE PAS OUVRIR	
<small>ATTENTION: PROTEGEZ CET APPAREIL DE LA PLUIE ET DE L'HUMIDITE AFIN D'EVITER TOUT RISQUE D'INCENDIE OU D'ELECTROCUTION. POUR REDUIRE D'ELECTROCUTION NE PAS ENLEVER LE COUVERCLE. AUCUNE PIECE INTERNE N'EST REPARABLE PAR L'UTILISATEUR. POUR TOUTE REPARATION, S'ADRESSEZ A UN TECHNICIEN QUALIFIE.</small>		

### IMPORTANT SAFETY INSTRUCTIONS

- READ, FOLLOW, HEED, AND KEEP ALL INSTRUCTIONS AND WARNINGS.
- DO NOT OPERATE NEAR ANY HEAT SOURCE AND DO NOT BLOCK ANY VENTILATION OPENINGS ON THIS APPARATUS. FOR PROPER OPERATION, THIS UNIT REQUIRES 3" (75mm) OF WELL VENTILATED SPACE AROUND HEATSINKS AND OTHER AIR FLOW PROVISIONS IN THE CABINET.
- DO NOT USE THIS APPARATUS NEAR SPLASHING, FALLING, SPRAYING, OR STANDING LIQUIDS.
- CLEAN ONLY WITH LINT-FREE DAMP CLOTH AND DO NOT USE CLEANING AGENTS.
- ONLY CONNECT POWER CORD TO A POLARIZED, SAFETY GROUNDED OUTLET WIRED TO CURRENT ELECTRICAL CODES AND COMPATIBLE WITH VOLTAGE, POWER, AND FREQUENCY REQUIREMENTS STATED ON THE REAR PANEL OF THE APPARATUS.
- PROTECT THE POWER CORD FROM DAMAGE DUE TO BEING WALKED ON, PINCHED, OR STRAINED.
- UNPLUG THE APPARATUS DURING LIGHTNING STORMS OR WHEN UNUSED FOR LONG PERIODS OF TIME.
- ONLY USE ATTACHMENTS, ACCESSORIES, STANDS, OR BRACKETS SPECIFIED BY THE MANUFACTURER FOR SAFE OPERATION AND TO AVOID INJURY.
- WARNING: TO REDUCE THE RISK OF ELECTRIC SHOCK OR FIRE, DO NOT EXPOSE THIS UNIT TO RAIN OR MOISTURE.
- SERVICE MUST BE PERFORMED BY QUALIFIED PERSONNEL.
- OUR AMPLIFIERS ARE CAPABLE OF PRODUCING HIGH SOUND PRESSURE LEVELS. CONTINUED EXPOSURE TO HIGH SOUND PRESSURE LEVELS CAN CAUSE PERMANENT HEARING IMPAIRMENT OR LOSS. USER CAUTION IS ADVISED AND EAR PROTECTION IS RECOMMENDED IF UNIT IS OPERATED AT HIGH VOLUME.



EXPLANATION OF GRAPHICAL SYMBOLS:

EXPLICACION DE SIMBOLOS GRAFICOS:

EXPLICATION DES SYMBOLES GRAPHIQUES:



"DANGEROUS VOLTAGE"

"VOLTAJE PELIGROSO"

"DANGER HAUTE TENSION"



"IT IS NECESSARY FOR THE USER TO REFER TO THE INSTRUCTION MANUAL"

"ES NECESARIO QUE EL USUARIO SE REFIERA AL MANUAL DE INSTRUCCIONES."

"REFERREZ-VOUS AU MANUAL D'UTILISATION"



## CA30D Acoustic Amplifier

### *Introduction:*

#### *Congratulations!*

You are now the proud owner of one of Crate's latest contributions to the world of acoustic amplification, the CA30D. This compact amplifier delivers a strong 30 watts of clear musical power and incorporates two inputs (each with a gain control), three bands of equalization, plus Crate's Contour control for added tonal flexibility. The CA30D features Crate's DSP digital reverb and effects, a front panel Insert (effects loop), and a Line Out jack. An 8" Polypropylene cone coaxial speaker delivers smooth clear sound with excellent projection and fidelity.

Your CA30D is Musician Made in the U.S.A., using only the best components. Extensive testing at the hands (and ears) of skilled technicians and musicians insures you that this amplifier is the absolute best it can be.

In order to get the most out of your new amplifier, we strongly urge you to go over the information contained in this manual before you begin playing.

And thank you for choosing CRATE.

***Crate Acoustic amplifiers are Made With Pride in the U.S.A.***

To keep this amplifier looking its best, avoid abrasive cleansers. Wipe the cabinet clean using a slightly dampened cloth. Never use brass cleaners on the hardware since they could damage their protective coatings.

## The Front Panel:

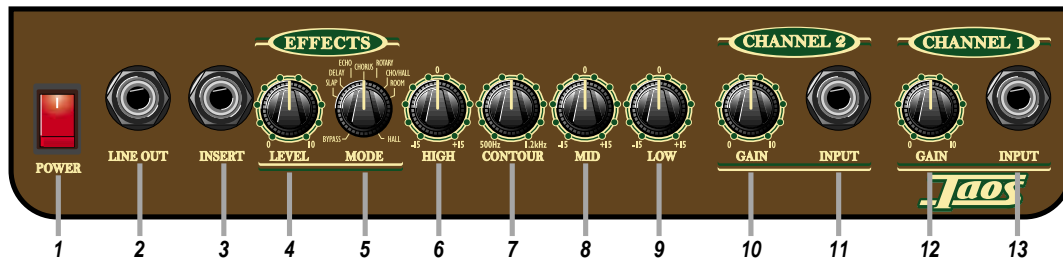

- 1: **Power.** Use this switch to apply power to the amplifier: the amp is on when the top of the switch is depressed, off when the bottom of the switch is depressed. The switch illuminates when the amp is on.
- 2: **Line Out.** Use this jack to connect a high impedance, unbalanced line level signal to a house sound board, a recording console or another amplifier.
- 3: **Insert.** Use this jack to add external effects to the signal. The ring = send (line out), tip = return (line in), sleeve = ground. This jack can also be used to “chain” multiple amplifiers together, since connecting to this jack does not interrupt the signal going to the amplifier. (See the illustrations on page 5 for more information.)
- 4: **Effects Level.** Use this control to adjust the amount of digital signal processing applied to the output signal.
- 5: **Effects Mode.** Use this control to select the type of digital signal processing applied to the output signal. (See the section entitled “The DSP Section” on page 6 for more information.)
- 6: **High.** This serves as the treble control for both channels. Adjust this control so your high notes and harmonic overtones are lively but not overpowering.
- 7: **Contour.** Use this control to set the center point of the mid control. This control should be set at the frequency which gives you the most natural midrange tones.
- 8: **Mid.** This serves as the midrange control for both channels. Adjust this control to get the best projection and midrange tones for your instrument. The center point of the mid control is chosen by the setting of the contour control (#7).
- 9: **Low.** This serves as the bass control for both channels. Adjust this control to get the best sounding bass response for your instrument. Excessive boost of the low control can cause an unnatural howling (acoustic feedback from your instrument) and should be avoided.
- 10,11,12,13: **Gain 2, Gain 1, Input 2, Input 1.** The signal output from your acoustic instrument, tape player, rhythm machine, high-Z microphone or other source may be connected to either or both of these jacks by means of a shielded signal cable. Each of the input jacks is governed by its corresponding gain control (#10 for Input 2, #12 for Input 1). The signals from these two jacks are summed together after their gain stages.
- 10,12: **Gain 2, Gain 1.** Use these controls to set the input gain level for the corresponding input jack. These controls set the level of the input signal and serve as the amplifier’s volume controls.
- 14: **AC Line Cord. (Rear panel, not shown)** The grounded power cord should only be plugged into a grounded power outlet that meets all applicable electrical codes and is compatible with the voltage, power, and frequency requirements stated on the rear panel. **Do not attempt to defeat the safety ground connection.**



# CA30D Acoustic Amplifier

## Connecting to the Insert Jack:

The Insert jack (#3) allows you to patch external effects into the amplifier just prior to its power amp stage. To connect the effect to the Insert jack use Crate's STP201, STP202, or STP203 stereo-to-mono Y-cord, or an adapter such as Crate's YPP117 and two shielded signal cables terminated with 1/4" tip/sleeve connectors as shown below.

For short runs, use Crate's STP201, STP202 or STP203 adapter to connect an effects device to the Insert jack:

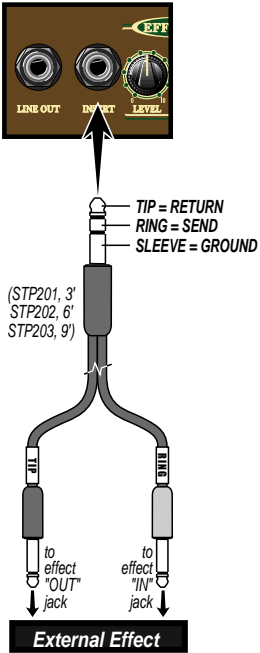

For longer runs, use Crate's YPP117 stereo-to-mono 1/4" adapter and two mono 1/4" signal cables to connect an effects device to the Insert jack:

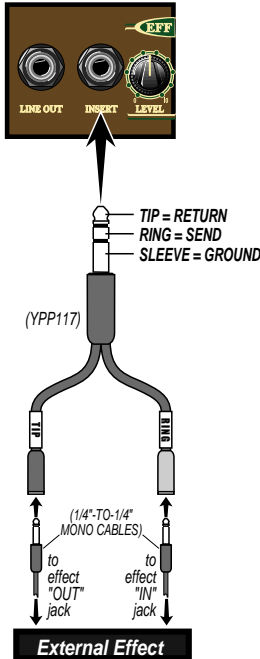

## "Chaining" Amplifiers:

The Line Out jack (#2) on one CA30D can be connected to the Insert jack of another, to chain the amps together as shown below. (This frees up the Input jacks of the second amplifier.) Use a shielded cable terminated with 1/4" tip/sleeve connectors as shown.

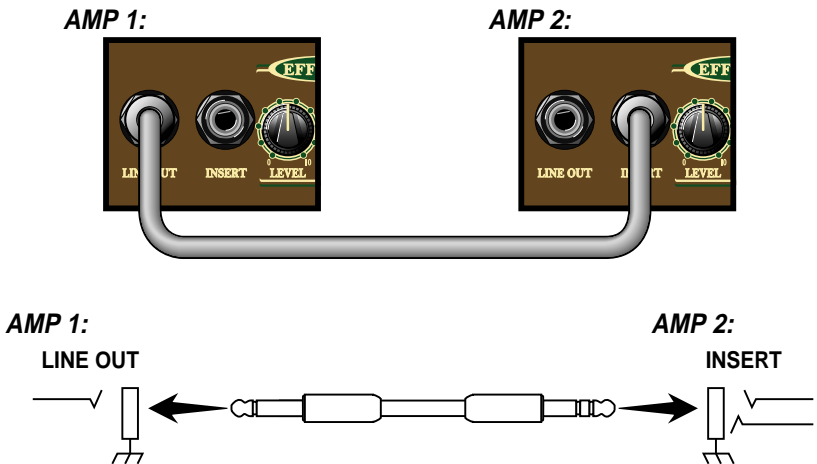



# CA30D Acoustic Amplifier

### The DSP Section:

The CA30D features Crate's DSP Digital Signal Processing. Use the Effects Mode control (#5) to select which type of effect will be applied to the amp's output signal. Use the Effects Level control (#4) to adjust the level of the effect.



The chart below lists the names of the effects as they appear on the amplifier and a description of their settings:

<i>Effect Name</i>	<i>Description</i>
<b>Bypass</b>	Signal processing is turned off
<b>Slap</b>	Short slapback, without regeneration
<b>Delay</b>	Medium slapback, with regeneration
<b>Echo</b>	Long delay, with regeneration
<b>Chorus</b>	Light chorus effect - medium-slow speed
<b>Rotary</b>	Simulated "Leslie Speaker" tremolo
<b>Cho/Hall</b>	Light chorus, with moderate reverberation
<b>Room</b>	Moderate reverberation
<b>Hall</b>	Heavy reverberation



# CA30D Acoustic Amplifier

## System Block Diagram:

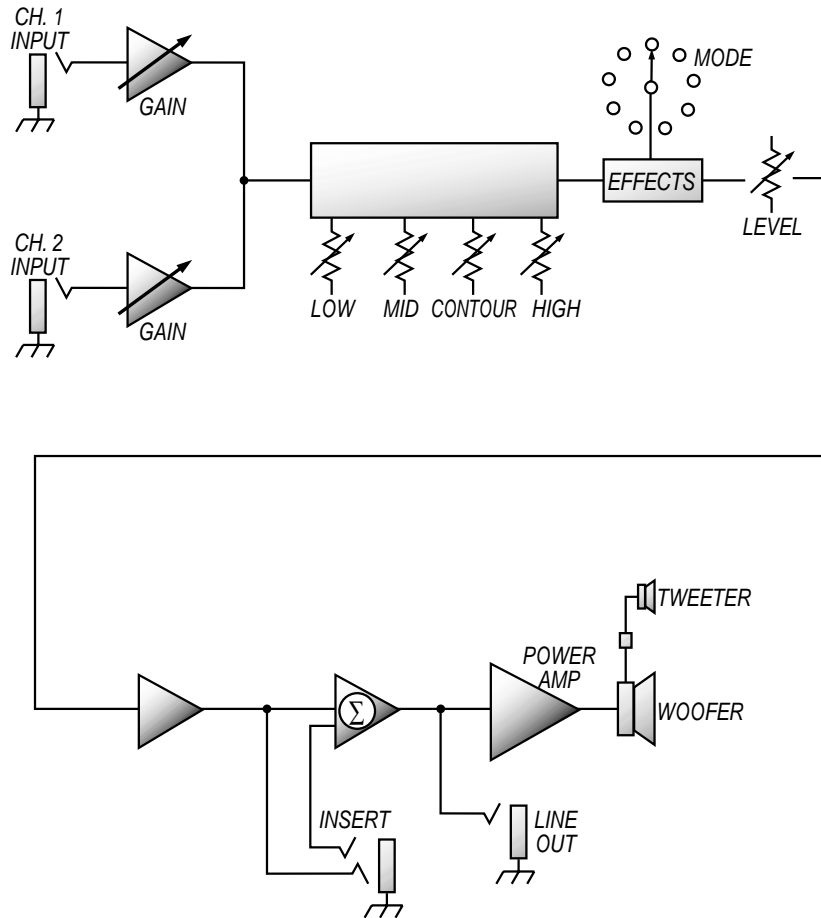

### Declaration Of Conformity

#33, Effective 01-01-2001

**Manufacturer's Name:** SLM Electronics  
**Production Facility:** 1901 Congressional Drive, St. Louis, MO 63146, USA  
**Production Facility:** 700 Hwy 202 W, Yellville, AR 72687, USA  
**Shipping Facility:** 1400 Ferguson Ave., St. Louis, MO 63133, USA  
**Office Facility:** 1400 Ferguson Ave., St. Louis, MO 63133, USA

**Product Type:** Audio Amplifier

#### Complies with the following Standards:

**Safety:** EN60065, E60065, C22.2, UL6500 and/or UL813  
**EMC:** Directive 89/336/EEC, EN55103, EN55013, EN61000, and/or FCC 47CFR 15B c/a

Supplementary information provided by:  
SLM Electronics - R & D Engineering  
1901 Congressional Drive, St Louis, MO 63146, USA  
Tel.: 314-569-0141, Fax: 314-569-0175



# CA30D Acoustic Amplifier

## *Technical Specifications:*

<b>Output Power Rating:</b>	30 watts RMS @ 1% distortion
<b>High:</b>	+/-15dB @ 10kHz
<b>Mid:</b>	+/-15dB @ 400-1.2kHz (Contour)
<b>Low:</b>	+/-15dB @ 80Hz
<b>Input Impedance:</b>	1.5M ohm
<b>Input Sensitivity:</b>	20mV RMS
<b>Sens. to Line out:</b>	20mV
<b>Max Input Signal:</b>	10v RMS (28v peak to peak)
<b>Insert Jack:</b>	Line Out .7v RMS, Line In .7v RMS
<b>Insert Jack Input Impedance:</b>	44k ohm
<b>Insert Jack Output Impedance:</b>	2.2k ohm
<b>Line Out Output Impedance:</b>	2.2k ohm (Lo-Z), 2.2k ohm (Hi-Z)
<b>Internal Speaker:</b>	8" Poly cone coaxial with dome tweeter; 4 ohms; 50 watts; 1" voice coil
<b>Power Requirements:</b>	120VAC, 60Hz, 50VA 100/115VAC, 50/60Hz, 50VA 230VAC, 50/60Hz, 50VA
<b>Size and Weight:</b>	13"H x 15"W x 12"D, 30 lbs.

*Crate continually develops new products, as well as improves existing ones. For this reason, the specifications and information in this manual are subject to change without notice.*



[www.crateamps.com](http://www.crateamps.com)

©2004 SLM Electronics  
A Division of St. Louis Music Co.  
1400 Ferguson Avenue  
St. Louis, MO 63133

47-939-02 • 011404

