

BP80

MODELING
BASS
PROCESSOR

DigTech
The Power to Create



Owner's
Manual

| |
|---|
| <div style="display: inline-block; text-align: center; margin: 0 10px;"> CAUTION <small>RISK OF ELECTRIC SHOCK DO NOT OPEN</small> </div> |
| ATTENTION: RISQUE DE CHOC ELECTRIQUE - NE PAS OUVRIR |
| WARNING: TO REDUCE THE RISK OF FIRE OR ELECTRIC SHOCK DO NOT EXPOSE THIS EQUIPMENT TO RAIN OR MOISTURE |

These symbols are internationally accepted symbols that warn of potential hazards with electrical products. The lightning flash means that there are dangerous voltages present within the unit. The exclamation point indicates that it is necessary for the user to refer to the owner's manual.

These symbols warn that there are no user serviceable parts inside the unit. Do not open the unit. Do not attempt to service the unit yourself. Refer all servicing to qualified personnel. Opening the chassis for any reason will void the manufacturer's warranty. Do not get the unit wet. If liquid is spilled on the unit, shut it off immediately and take it to a dealer for service.

Disconnect the unit during storms to prevent damage.

Electromagnetic Compatibility

Operation is subject to the following conditions:

- This device may not cause harmful interference
- This device must accept any interference received, including interference that may cause undesired operation.
- Use only shielded interconnecting cables.
- Operation of this unit within significant electromagnetic fields should be avoided

Warning

For your protection, please read the following:

Water and Moisture: Appliances should not be used near water (e.g. near a bathtub, washbowl, kitchen sink, laundry tub, in a wet basement, or near a swimming pool, etc.) Care should be taken so that objects do not fall and liquids are not spilled into the enclosure through openings.

Power Sources: The appliance should be connected to a power supply only of the type described in the operating instruction or as marked on the appliance.

Grounding or Polarization: Precautions should be taken so that the grounding or polarization means of an appliance is not defeated.

Power Cord Protection: Power supply cords should be routed so that they are not likely to be walked on or pinched by items placed upon or against them, paying particular attention to cords at plugs, convenience receptacles, and the point where they exit from the appliance.

Servicing: To reduce the risk of fire or electrical shock, the user should not attempt to service the appliance beyond that described in the operating instructions. All other servicing should be referred to qualified service personnel.

For units equipped with externally accessible fuse receptacles: Replace fuse with same type and rating only.

DECLARATION OF CONFORMITY

Manufacturer's Name: DigiTech
Manufacturer's Address: 8760 South Sandy Parkway
Sandy, Utah 84070 USA

declares that the product:

Product name: BP80
Product option: all (requires Class II power adapter that conforms to the requirements of EN60065, EN60742, or equivalent.)

conforms to the following Product Specifications:

Safety: EN 60065 (1998)

EMC: EN 55013 (1990)
EN 55020 (1991)

Supplementary Information:

The product herewith complies with the requirements of the Low Voltage Directive 72/23/EEC and the EMC Directive 89/336/EEC as amended by Directive 93/68/EEC.

Vice-President of Engineering
8760 S. Sandy Parkway
Sandy, Utah 84070, USA
Date: February 13, 2004

European Contact: Your local DigiTech Sales and Service Office or

Harman Music Group
8760 South Sandy Parkway
Sandy, Utah 84070 USA
Ph: (801) 566-8800
Fax: (801) 568-7583

Warranty

We at DigiTech are very proud of our products and back-up each one we sell with the following warranty:

1. The warranty registration card must be mailed within ten days after purchase date to validate this warranty.
2. Digitech warrants this product, when used solely within the U.S., to be free from defects in materials and workmanship under normal use and service.
3. Digitech liability under this warranty is limited to repairing or replacing defective materials that show evidence of defect, provided the product is returned to Digitech WITH RETURN AUTHORIZATION, where all parts and labor will be covered up to a period of one year. A Return Authorization number may be obtained from Digitech by telephone. The company shall not be liable for any consequential damage as a result of the product's use in any circuit or assembly.
4. Proof-of-purchase is considered to be the burden of the consumer.
5. Digitech reserves the right to make changes in design, or make additions to, or improvements upon this product without incurring any obligation to install the same on products previously manufactured.
6. The consumer forfeits the benefits of this warranty if the product's main assembly is opened and tampered with by anyone other than a certified Digitech technician or, if the product is used with AC voltages outside of the range suggested by the manufacturer.
7. The foregoing is in lieu of all other warranties, expressed or implied, and Digitech neither assumes nor authorizes any person to assume any obligation or liability in connection with the sale of this product. In no event shall Digitech or its dealers be liable for special or consequential damages or from any delay in the performance of this warranty due to causes beyond their control.

NOTE: The information contained in this manual is subject to change at any time without notification. Some information contained in this manual may also be inaccurate due to undocumented changes in the product or operating system since this version of the manual was completed. The information contained in this version of the owner's manual supersedes all previous versions.

Introduction

Getting Acquainted

Congratulations on your purchase of the BP80. The BP80 is a revolutionary amp modeling multi-effects processor for the performing bassist. Powered by DigiTech®'s Audio DNA™ DSP processor, the BP80 features 16 amp and stompbox models and a host of other effects designed to help you create and define your own signature sound. Although, the BP80 is so user friendly you may not even need to read this manual, we recommend you become better acquainted with us and what we have to offer by going through this Owner's Manual with your BP80 in front of you. It is your key to unlocking the potential within the BP80.

Included Items

Before you get started, please make sure that the following items have been included:

- **BP80**
- **PS200R Power Supply**
- **This Owner's Manual**
- **Warranty Card**

The utmost care was taken while your BP80 was being manufactured. Everything should be included and in perfect working order. If anything is missing, contact the factory at once. Please help us become acquainted with you and your needs by completing your warranty card or registering online at <http://www.digitech.com>. It is your safeguard should a problem arise with your BP80.

The Front Panel

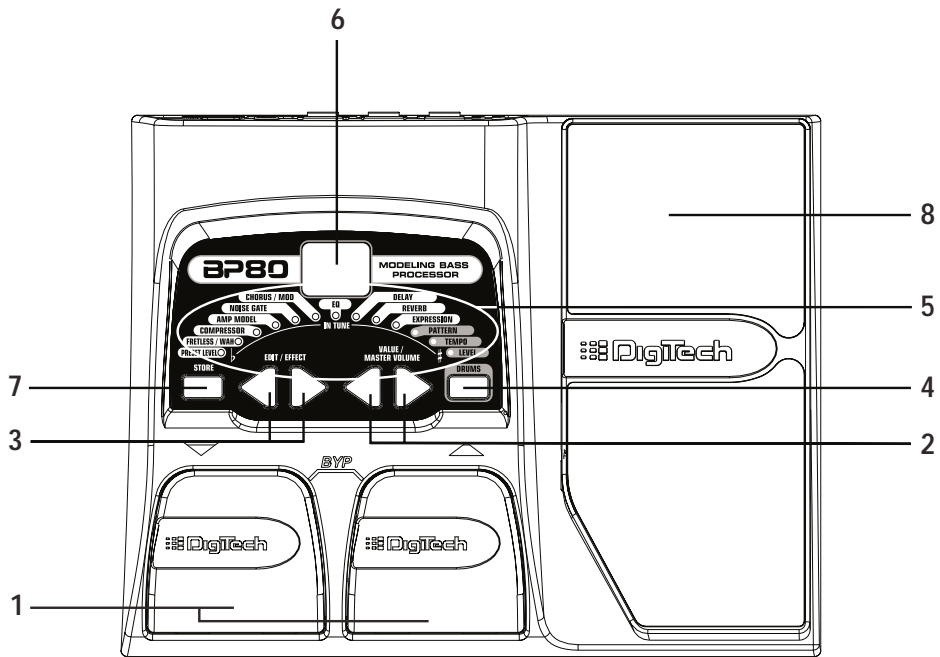

1. **Footswitches** - These 2 Footswitches are used to select presets, access the Tuner, or bypass the BP80. The Up Footswitch increments, and the Down Footswitch decrements through the presets. Pressing both Footswitches simultaneously bypasses the selected preset. Pressing and holding both Footswitches accesses the Tuner.
2. **Value/Volume Buttons** - The Value Buttons perform various value adjustment functions for the BP80. These buttons are used to control the BP80's Master Level, adjust a selected effect, and also change the Pattern, Tempo, and Level of the Drum machine when it is turned on. When the Tuner is enabled, these buttons select the tuning reference.
3. **Edit/Effect Buttons** - Pressing either of the Edit/Effect buttons enters Edit mode and selects the individual effects to be edited. Press the left and right Edit buttons to move through the effects. Each effect LED will light to indicate which effect you are editing
4. **Drums** - The Drums button is used to turn on and off the BP80's drum machine. When the Drums are active, the Drums LED lights and the selected drum pattern plays continuously.
5. **Effect LEDs** - The Effect LEDs show which effects are active in the current preset. In Edit mode, the LEDs indicate the effect selected for editing. In Tuner mode, the LEDs indicate whether the note played is sharp, flat, or in tune.

- 6. Display** - The Display provides information for different functions depending on the selected mode. In Play mode, the display shows the selected preset number. In Edit mode, the display shows the value of the parameter being adjusted. When the Tuner is selected, the display shows the note being played.
- 7. Store** - The Store button saves your custom changes to the user presets.
- 8. Expression Pedal** - The Expression Pedal controls the BP80's Volume or the assigned Effect Parameter in real time. See page 21 for a list of available parameters.

Rear Panel

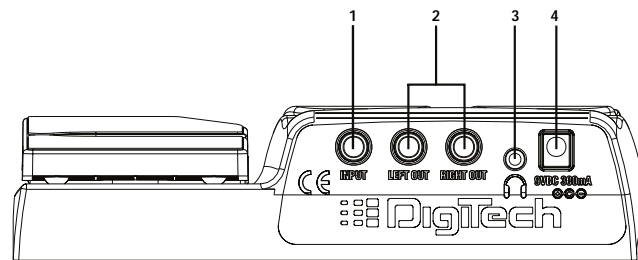

1. **Input** - Connect your instrument to this jack.

2. **1/4" Outputs** - Connect these outputs to your amplifier or direct to a mixing console that accepts 1/4" unbalanced connections. Use the Left Output for all mono applications.

Note: When using the BP80 direct into a mixer or recording device, or when using it with headphones, you can enable the Global Cabinet Modeling feature to emulate speaker simulation on each of the BP80's presets. (See Page 23 for more on Global Cabinet Modeling.)

3. **Headphone Output** - Connect a pair of stereo headphones to this 1/8" jack.

4. **Power Input** - Connect only the DigiTech PS200R power supply to this jack.

Making Connections

There are several different connection options available when using the BP80. The following diagrams show the connections for some of these options.

Before connecting the BP80, make sure that the power to your amplifier is turned off, and the power to the BP80 is disconnected. There is not a power switch on the BP80. To turn the BP80 off, disconnect your instrument from the Input Jack (for battery power) or disconnect the PS200R power supply from the Power Jack or the AC outlet.

Mono Operation

Connect your bass to the Input of the BP80. Connect a single mono instrument cable from the Left Output of the BP80 to the instrument input on your amplifier.

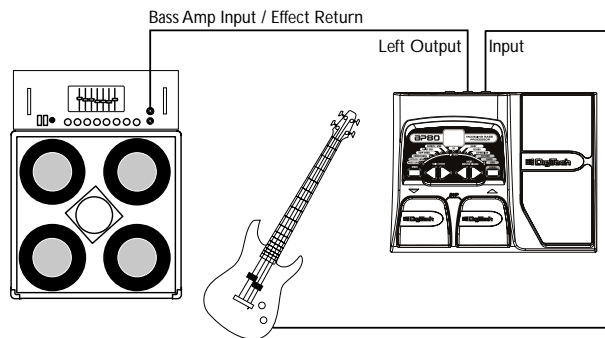

Stereo Operation

For stereo operation connect your bass to the Input of the BP80. Connect from the BP80's Left/Mono Output to the input of one amplifier or to a channel input of a mixing console. Connect from the BP80's Right Output to a second amplifier, or to a second channel of a mixing console. If connecting to a mixing console, set the pan controls of the mixer hard left and right to retain stereo separation. To emulate a bass cabinet sound when using the BP80 with a mixer or headphones, you can enable Global Cabinet Modeling (see page 23).

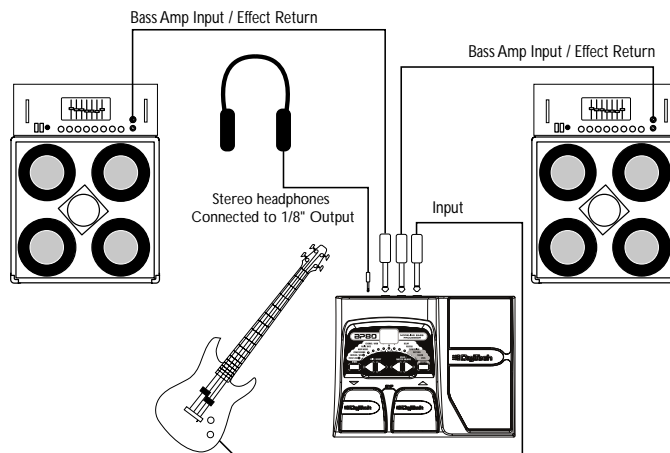

Applying Power

There are two options for powering the BP80: battery power, and the included PS200R DC power supply. Before applying power to anything, set your amp(s) to a clean tone and set the tone controls to a flat EQ response (on most amps, this would be 0 or 5 on the tone controls).

Battery Power

The BP80 can be run for more than 15 hours on 6 AA batteries. The battery compartment is located on the bottom of the BP80. The following diagram shows how to install the batteries.

Note: Pay close attention to the battery polarity when installing batteries as polarity changes direction for each pair.

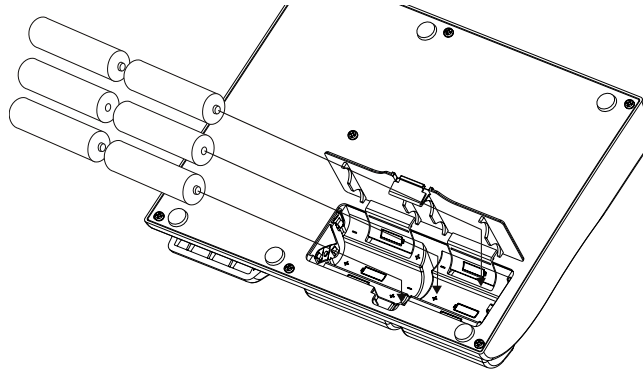

Connecting an instrument cable to the Input applies power to the BP80. Disconnecting your instrument from the Input of the BP80 disconnects the battery power. Turn your amplifier(s) on and adjust the volume(s) to a normal playing level. To prolong the battery life, disconnect your instrument from the BP80's Input when it is not in use .

AC Power

The BP80 can also be powered with the included PS200R power supply. Connect the plug of the PS200R power supply to the power jack on the rear panel of the BP80. Connect the other end of the PS200R power supply to an AC outlet. Turn your amplifier(s) on and adjust the volume(s) to a normal playing level.

About the BP80

The Presets

Presets are numbered locations of programmed sounds. Presets are recalled with the Footswitches. The BP80 comes with 40 User Presets (Presets 1-40) and 40 Factory Presets (Presets 41-80). The User Presets are locations where you can store presets. The Factory Presets may not be saved over. From the factory, the 40 User Presets are exact duplicates of the 40 Factory Presets.

Tuner

The Tuner in the BP80 lets you quickly tune or check the tuning of your bass. Press and hold both Footswitches simultaneously to access the tuner. A $\text{E} \cup$ briefly displays indicating that you are in Tuner mode. To begin tuning, play a note on your bass (the neck pickup usually works best). The display shows the note being played. The Effect LEDs indicate whether the note is sharp or flat. The right 6 red LEDs indicate the note is sharp and should be tuned down. The left 6 red LEDs indicate the note is flat and should be tuned up. The center Green LED indicates the note is in tune. The output is muted in Tuner mode. Pressing down on the Expression Pedal returns sound to the signal and controls the bypass volume.

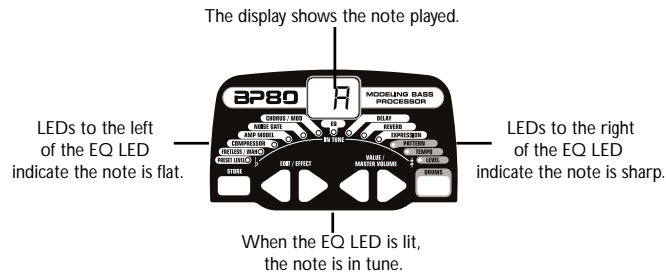

When the Tuner is enabled, you can change your tuning reference. The default factory setting is A=440 Hz. (displayed as 40). Press the Value Buttons to select alternate dropped tunings. Alternate tunings are A = Ab (displayed as Ab), A = G (displayed as G), and A = Gb (displayed as Gb). The display window briefly flashes the selected tuning preference.

Exit tuner mode by pressing either Footswitch. The tuning reference is retained when the unit is turned off.

Bypass

The BP80 presets can be bypassed for a clean, unprocessed bass tone. To bypass the BP80, press both footswitches simultaneously. The display reads **bY** indicating the preset is bypassed. Press either footswitch to exit Bypass and return the the last selected preset.

Editing/Creating Presets

Creating your own signature sound with the BP80 is easy and intuitive. The BP80 lets you create your own presets, or fine tune existing Presets to suit your needs. When creating or editing a sound, you must start with a User or Factory Preset. It is not possible to start with an empty preset. You can save your preset to any User Preset location while storing the preset (see Storing a Preset on page 13).

To edit or create a Preset:

1. Press the **FOOTSWITCHES** to select a preset
2. Press the **EDIT** buttons in conjunction with the Effect LEDs to choose the effect you want to edit.
3. Press the **VALUE** Buttons to change the parameter values.

The Effect LEDs

When editing a preset, the Effect LEDs are used to identify which effect is selected for editing. The Edit/Effect buttons move you through the Effect modules. The LEDs light identifying which effect group is selected. Each effect has multiple settings to select from. The Value buttons are used to change the value for the selected effect. As a button is pressed, the value or status is shown in the display.

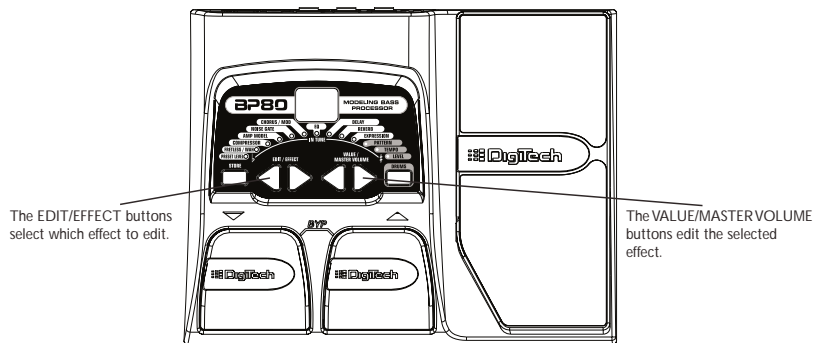

When the stored value of an effect is changed, the lower right decimal point in the display lights indicating you need to store the changes. Changing presets, or turning the power off before storing any changes will erase any changes made and revert to the stored values for the preset.

Effect Definitions

The BP80 can be thought of as several different “virtual” amplifiers, and individual hi-tech effects. Each effect within the BP80 can be programmed to suit your personal application. Understanding how these effects alter the sound helps you achieve the sound you are looking for. The following overview of the BP80's effects outlines what each effect does.

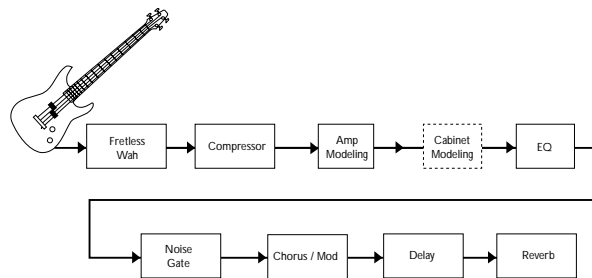

Preset Level

Controls the individual level for each preset. Because this setting is individual to each preset, you may adjust the volume when using louder or softer amp models.

Fretless/Wah

The fretless simulator creates a fretless bass sound when using a fretted bass. Wah is an effect controlled by an expression pedal making the bass sound as if it's saying “Wah.”

Fretless/Wah Type - The Value buttons select the Fretless or Wah type that is simulated.

The Fretless effect has 30 types (10-39). The first digit shows the fretless type, the second digit (0-9) selects the fretless variation. When Cr , bO , or Fr are displayed, the Wah effect has been selected and is controlled with the Expression Pedal.

| | | |
|-----------------------------------|-----------------------------------|-----------------------------------|
| OF = off | S = Amount 55/ Attack 55 | Q = Amount 99/ Attack 91 |
| I = Amount 19/ Attack 16 | B = Amount 99/ Attack 55 | Cr – Cry Wah |
| Z = Amount 55/ Attack 16 | 7 = Amount 99/ Attack 75 | bO – Boutique Wah |
| 3 = Amount 99/ Attack 16 | B = Amount 20/Attack 91 | Fr – Full Range Wah |
| 4 = Amount 19/ Attack 55 | 9 = Amount 55/ Attack 91 | |

Compressor

A Compressor is used to automatically limit the dynamic level of the bass signal. The Compressor effect has 110 different settings (00-99;F0-F9). The first digit represents the crossover frequency. Any signal below this frequency is compressed. The second digit (0-9) increases the amount of compression.

| | | |
|-------------------|--------------------|-------------------------|
| OF = off | 3 = 100Hz | 7 = 630Hz |
| Q = 50Hz | 4 = 160Hz | B = 1kHz |
| I = 63Hz | 5 = 250Hz | 9 = 1.6kHz |
| Z = 80Hz | B = 400Hz | F = Full Range |

(Example: a compressor setting of 62 would be a crossover frequency of 400 Hz with a compression amount of 2.)

Amp/Stompbox Modeling

Modeling is a technology that reproduces the tones of popular modern and vintage amps and distortion stompboxes. Values 1-9 increase the amp or stompbox gain and level.

| | |
|--|---|
| <i>r</i> 1- <i>r9</i> – based on an Ampeg SVT | <i>y</i> 1- <i>y9</i> – based on a Mesa/Boogie 400+ |
| <i>A</i> 1- <i>A9</i> – based on an Ashdown Bass Magnifier | <i>c</i> 1- <i>c9</i> – based on a SWR Basic Black |
| <i>b</i> 1- <i>b9</i> – based on a Fender Bassman | <i>d</i> 1- <i>d9</i> – based on a Fender Dual Showman |
| <i>S</i> 1- <i>S9</i> – based on a Sunn 200S | <i>F</i> 1- <i>F9</i> – DigiFuzz Fuzz distortion |
| <i>I</i> 1- <i>I9</i> – based on an SWR Interstellar Overdrive | <i>G</i> 1- <i>G9</i> – based on a Guyatone OD-1 |
| <i>t</i> 1- <i>t9</i> – based on a Trace-Elliot Commando | <i>P</i> 1- <i>P9</i> – based on a EH Big Muff Pi |
| <i>a</i> 1- <i>a9</i> – based on a Ampeg B15 | <i>L</i> 1- <i>L9</i> – based on a Voodoo Labs SparkleDrive |
| <i>H</i> 1- <i>H9</i> – based on a Hiwatt Custom 50 | <i>n</i> 1- <i>n9</i> – based on a Boss DS-1 |

All names are the property of their respective companies and are in no way associated with DigiTech.

EQ

Equalization is used to shape the tonal response of your bass guitar signal. The EQ in the BP80 is similar to the tone knobs on an amplifier. Values 1-4 cut the level of each band, 5 is flat (no cut or boost), and values 6-9 boost the level of each band.

Bass (*b* 1- *b9*) - The Value buttons adjust the amount of low end enhancement (Bass).

Mid (*d* 1- *d9*) - The Value buttons adjust the amount of mid range enhancement.

Treble (*t* 1- *t9*) - The Value buttons adjust the amount of high end enhancement (Treble).

Noise Gate

A Noise Gate is designed to eliminate noise while you are not playing. The AutoSwell

setting creates a volume pedal effect automatically with varying attack times. Different bass guitars and pickups require different threshold settings. Choose a setting that fully mutes the sound when you are not playing.

□F. G 1-69 - Selects the Silencer™ Noise Gate. Settings 1-9 select the threshold. Of turns the gate effect off.

5 1-59 - Selects the Auto Swell volume swell effect. Settings 1-9 select the attack time.

Chorus/Mod

The Chorus/Mod module is a multi-function module that lets you select the following effects: Chorus, Flanger, Phaser, Vibrato, SynthTalk™, Octavider, Envelope, Detune, Pitch Shift, and Whammy™ effects. When the Chorus/Mod module is selected, the Value buttons are used to choose the type of effect. Only one of the effects in this row can be used at a time. The following list describes each effect and their parameters in more detail.

Chorus (C 1-69)

A Chorus adds a short delay to your signal. The delayed signal is modulated in and out of tune and then mixed back with the original signal to create a thicker sound, and stereo image. Use the Value buttons to select one of the nine Chorus settings.

Flange (F 1-69)

A Flanger uses the same principle as a Chorus but uses a shorter delay time and adds regeneration (or repeats) to the modulating delay. This results in an exaggerated up and down sweeping motion to the effect. Use the Value buttons to select one of the nine Flanger settings.

Phaser (P 1-P9)

A phaser splits the incoming signal, and changes the phasing of the signal. The signal is taken in and out of phase and mixed back in with the original signal. As the phasing changes, different frequencies get canceled resulting in a warm sort of twisting sound. Use the Value buttons to select one of the nine Phaser settings.

Vibrato (b 1-b9)

A Vibrato effect modulates the pitch of the incoming signal at an even rate. Use the Value buttons to select one of the nine Vibrato settings.

SynthTalk™ (S 1-S9)

SynthTalk uses formant style filtering that produces vocal and vowel sounds. This gives the illusion of a synthesized talking bass and is especially effective when used with a stomptbox model.

Octavider (o 1-o9)

The Octavider effect creates a smooth tracking unison note one octave below the note being played.

Envelope Filter (E 1-E9)

The Envelope Filter is a dynamic Wah effect that alters your sound based upon how hard you play. Use the Value buttons to select one of the nine Envelope Filter settings.

Detune (d 1-d9)

A Detuner makes a copy of your incoming signal, takes the copied signal slightly out of tune from the original, and mixes the two signals together. The result is a doubling type of effect as if two bass guitars were playing the same part together. Use the Value buttons to select one of the nine Detuner settings.

Pitch Shift (H 1-H9)

The Pitch Shifting copies the incoming signal, and shifts the pitch of the copy to a different note. The shifted note is mixed back with the original signal sounding as if two bass guitars were playing different notes. Use the Value buttons to select one of the nine Pitch Shift settings. The Pitch Shift settings are as follows:

| | | |
|--------------------|-------------------|--------------------|
| H 1= -12 semitones | H 4= -4 semitones | H 7= +5 semitones |
| H 2= -7 semitones | H 5= +3 semitones | H 8= +7 semitones |
| H 3= -5 semitones | H 6= +4 semitones | H 9= +12 semitones |

Whammy™ (Y 1-Y9)

Whammy™ is an effect that uses the Expression Pedal to bend the pitch of the incoming signal, or add a bendable harmony with the original signal. As the Pedal is moved, the note bends either up or down. Use the Value buttons to select one of the nine Whammy™ settings. **W** denotes Whammy bends and **H** denotes harmony bends. The Whammy settings are as follows:

| | | |
|----------------------------|-------------------------------|---------------------------|
| Y 1= W Octave Up | Y 4= W 2 Octaves Down | Y 7= H 3rd/4th Up |
| Y 2= W 2 Octaves Up | Y 5= H m3rd/Maj 3rd Up | Y 8= H Octave Up |
| Y 3= W Octave Down | Y 6= H 2nd/Maj 3rd Up | Y 9= H Octave Down |

Delay

The BP80 has 3 different delay types, Mono (d), Analog (R), and Ping Pong (P), each with up to 2 seconds of delay time available. There are two different parameters used to program the delay, Delay Type/Variation and Time. The first parameter of the delay effect is Delay Type/Variation, which selects the delay type to be used and varies the amount of feedback (number of repeats) and level. The second delay parameter is Delay Time. This is indicated by the values 1-99 (10 milliseconds to 990 milliseconds) in 10 millisecond increments, and 1.0 through 2.0 (1 to 2 seconds) in 100 millisecond increments. The Delay Time is shown in the display when the Delay LED is lit. Delay settings are as follows:

| | | |
|-------------------------------|-------------------------------|-------------------------------|
| d, R, P 1=5% fback, level 15 | d, R, P 4=5% fback, level 30 | d, R, P 7=5% fback, level 50 |
| d, R, P 2=25% fback, level 15 | d, R, P 5=25% fback, level 30 | d, R, P 8=25% fback, level 50 |
| d, R, P 3=50% fback, level 15 | d, R, P 6=50% fback, level 30 | d, R, P 9=50% fback, level 50 |

Reverb

Using reverb in recorded program material gives the listener a sense that the material is being performed in an actual room or hall. It is this similarity to actual acoustic spaces that makes reverberation a useful tool in recorded music. Use the Value buttons to select one of the nine predetermined settings. The higher numbers indicate there is more reverb level. The reverb settings are as follows:

| | |
|-----------------|------------------|
| r 1-r 9 = Room | [- 1-[- 9=Church |
| H 1-H 9 - Hall | R 1-R 9 = Arena |
| P 1-P 9 - Plate | S 1-S 9 - Spring |

Other Functions

Expression Pedal

The Expression Pedal on the BP80 can be assigned to control the Volume, Wah, Whammy™, or one of several other parameters in real time. When a parameter has been assigned to the Expression Pedal, a programmable minimum and maximum value can also be assigned. The procedure for assigning a parameter to the Expression Pedal is as follows:

1. Press the Right Edit/Effect button until the Expression LED flashes. An effect LED will also light indicating which effect the expression pedal is currently assigned to.
2. Press either one of the Value/Master Volume buttons until your desired effect's LED is lit. The Expression LED will continue to flash during your selection and the Display will show a two-digit character value to describe the effect parameter that the expression pedal is assigned to. Your choices include:

| | |
|---------------|--|
| No Assignment | -- |
| Volume | <i>VL</i> (Output Level) |
| Wah | <i>WH</i> (Expression Pedal acts as a Wah pedal) |
| Amp | <i>GA</i> (Expression Pedal controls the Amp Gain) |
| Chorus | <i>SP</i> (Speed), <i>LE</i> (Level) |
| Flanger | <i>SP</i> (Speed), <i>LE</i> (Level) |
| Phaser | <i>SP</i> (Speed), <i>LE</i> (Level) |
| Vibrato | <i>SP</i> (Speed), <i>DP</i> (Depth) |
| SynthTalk | <i>SS</i> (Sensitivity) |

| | |
|-------------|---|
| Octavider | LE (Level) |
| Envelope | ES (Sensitivity) |
| Detune | LE (Level) |
| Pitch Shift | LE (Level) |
| Whammy | hY (Shift) |
| Delay | dL (Delay Level), dF (Delay Feedback - 99 = Infinite Repeat*) |
| Reverb | rL (Reverb Level) |

3. To adjust the minimum value limit (heel down) and maximum value limit (toe down) do the following:

- A. Press the Right Edit/Effect button. The Display will flash between HE (heel) and the value you have selected.
 - B. Select the your desired value by pressing either of the left or right Value/ Master Volume buttons.
 - C. Press the Right Edit/Effect button once more and the Display will flash between the EA (toe), or maximum value position and the value you have selected.
 - D. Select your desired value by pressing either the left or right Value/Master Volume buttons.
- (The value range for each assignable parameter is 1-99)

4. Store your Expression Pedal assignment values to your Preset. See page 13 for more information on the storing procedure.

*Infinite Repeat creates a playback loop of whatever signal was played into the delay.

Drum Machine

The BP80 includes several sampled drum patterns that are useful for developing a good sense of timing. Press the Drums button to start playback of the drum machine (except when in Store or Bypass mode). The Edit buttons select the drum Pattern, Tempo, and Level of the drum loop. Press the Drums button again to stop playback of the drum machine.

Global Cabinet Modeling

The BP80 includes cabinet modeling that can be enabled on all presets when running it into a mixer, recording device, or when using it with headphones. This feature emulates a speaker cabinet connected to each of the amp models in all presets. Each amp model has a specific cabinet model that optimizes its sound when using the BP80 in this manner. To enable Cabinet Modeling:

Press and hold the **DRUMS** button then apply power to the BP80. Wait until the display reads `CRB on EE On`. Release the Drums button.

Cabinet Modeling is now enabled for all amp models in all presets. The following lists what cabinet accompanies each model:

| | | | |
|---------------|-----------------|---------------|-----------------|
| <i>r 1-r9</i> | - 8x10 Cabinet | <i>0 1-09</i> | - 4x10H Cabinet |
| <i>A 1-A9</i> | - 4x10H Cabinet | <i>t 1-t9</i> | - 2x15 Cabinet |
| <i>b 1-b9</i> | - 4x10 Cabinet | <i>o 1-o9</i> | - 1x15 Cabinet |
| <i>S 1-S9</i> | - 2x15 Cabinet | <i>H 1-H9</i> | - 4x10 Cabinet |

Y 1-49 - 2x15 Cabinet
c 1-c9 - 4x10H Cabinet
d 1-d9 - 2x15 Cabinet
F 1-F9 - 2x15 Cabinet

G 1-G9 - 2x15 Cabinet
P 1-P9 - 2x15 Cabinet
L 1-L9 - 2x15 Cabinet
n 1-n9 - 2x15 Cabinet

Drum Machine

The BP80 includes several sampled drum patterns that are useful for developing a good sense of timing. Press the Drums button to start playback of the drum machine (except when in Store or Bypass mode). The Edit buttons select the drum Pattern, Tempo, and Level of the drum loop. Press the Drums button again to stop playback of the drum machine.

Factory Reset

This function resets the BP80 to its original factory settings. This procedure erases all custom user presets. **Performing this function erases all user-programmed data. All such data will be lost forever!**

The procedure for performing a Factory Reset is as follows:

1. Disconnect the power supply from the BP80 (AC Power) or unplug the bass guitar from the input jack (battery power).
2. Press and hold the left **EDIT** button while re-connecting the power or plugging your bass guitar into the BP80's input.
3. When the display reads --, release the button and press the **STORE** button. The display reads rE. The BP80 is now restored to its factory settings.

Expression Pedal Calibration

The Expression Pedal on the BP80 needs to be recalibrated for use after a factory reset has been performed. This calibration procedure is automatically entered after a factory reset procedure. In the event the Pedal's calibration fails, or if the Pedal does not function properly, it can be re-calibrated using the Pedal Calibration procedure. This will not erase the User Presets. The procedure for Calibrating the Expression Pedal is as follows:

1. Disconnect the power supply from the power jack (AC power) or unplug your bass guitar from the input jack (battery power).
2. Press and hold the **Down Footswitch** while re-connecting the power by either connecting the power supply to the BP80's power jack (AC power) or plugging your bass into the BP80's input (battery power).
3. Continue to hold the **Down Footswitch** until the **Display** reads E_C .
4. Rock the **Expression Pedal** back to the toe up position (**Display** will read UP).
5. Press the **Up Footswitch** and the **Display** now shows d_n .
6. Rock the **Expression Pedal** forward to the toe down position.
7. Press the **Down Footswitch**. The BP80 will return to the last selected Preset and the Expression Pedal is now calibrated.

Note: If the Display shows E_r , an error has occurred and steps 4 through 7 should be repeated.

Appendix

Specifications:

Input: 1/4" input

Output: (2) - 1/4" (unbalanced)

Headphone Output: 1/8" stereo input

A/D/A: 24 bit Delta Sigma

Power Supply: 6 AA Batteries or DigiTech PS200R (9VDC) power supply

Power Consumption: 5 Watts Maximum (with PS200R power supply)

Battery Life: >15 hours with continuous useage

Memory: 40 User/40 Factory Presets

Effects: Fretless/ Wah, Compressor, 11 Amp Models, 5 Stompbox Models, 3 band EQ, Noise Gate, Cabinet Modeling, Chorus, Flange, Phaser, Vibrato, SynthTalk™, Octavider, Envelope Filter, Pitch Shift, Detune, Whammy™, Delay, and Reverb

Drum Machine: 30 Patterns plus metronome

Simultaneous Effects: up to 8

Dimensions: 6.3" L x 8.125" W x 2.0"H (2.82"H with pedal in up position)

Weight: 1.34 lbs. (1.98 lbs. w/ power supply.)

Preset List (User/Factory)

| | | | |
|-------|-------------------|-------|---------------|
| 1/41 | Punchy | 21/61 | Fuzz Phase |
| 2/42 | Phased Hall | 22/62 | Sparkle Grit |
| 3/43 | Basic Sub | 23/63 | Detuned Room |
| 4/44 | Funky Filter | 24/64 | Flange Plate |
| 5/45 | Chorus Hall | 25/65 | Rock Grind |
| 6/46 | Rock Amped | 26/66 | Rock Church |
| 7/47 | Basic Chorus | 27/67 | Grinder |
| 8/48 | Filter Up | 28/68 | Swell Space |
| 9/49 | Phasadelic | 29/69 | Phase Delay |
| 10/50 | Rock Out | 30/70 | Wham Down |
| 11/51 | Light Drive | 31/71 | DS Grind |
| 12/52 | Fretless Walk | 32/72 | OctaPie |
| 13/53 | Compressed Chorus | 33/73 | Thick Bottom |
| 14/54 | Just Basic | 34/74 | Funky Phase |
| 15/55 | Synth Sweep | 35/75 | Plate Grinder |
| 16/56 | Boogey Flange | 36/76 | Bass Man |
| 17/57 | Rubber Bandy | 37/77 | Traced |
| 18/58 | Thickness | 38/78 | ShowMan |
| 19/59 | Church Delay | 39/79 | Sunn Shine |
| 20/60 | Guy O | 40/80 | Amped |

DigiTech
8760 South Sandy Parkway
Sandy, Utah 84070
PH (801) 566-8800
FAX (801) 566-7005

DigiTech® is a registered trademark
of the Harman Music Group Inc.

Copyright - Harman Music Group

Printed 2/2004

Printed in USA

BP80 Modeling Bass Processor
Owner's Manual 18-0281

Please visit DigiTech
on the World Wide Web at:
www.digitech.com

 A Harman International Company