



Spider Jam

Pilot's Handbook

Manuel de pilotage

Pilotenhandbuch

Pilotenhandboek

Manual del Piloto

An in-depth exploration of the advanced technologies and pulsing tonal pleasures of Spider Jam.

WARNING: To reduce the risk of fire or electric shock, do not expose this appliance to rain or moisture.

CAUTION: To reduce the risk of fire or electric shock, do not remove screws. No user-serviceable parts inside. Refer servicing to qualified service personnel.

NOTICE: This equipment has been tested and found to comply with the limits for a Class B digital device pursuant to Part 15 of FCC Rules. Operation is subject to the following two conditions: (1) This device may not cause harmful interference, and (2) this device must accept any interference received, including interference that may cause undesired operation.



The lightning symbol within a triangle means “electrical caution!” It indicates the presence of information about operating voltage and potential risks of electrical shock.



The exclamation point within a triangle means “caution!” Please read the information next to all caution signs.

The serial number can be found on the back panel of your Spider Jam. It’s the number that begins with “(21)”. Please note it here for future reference:

SERIAL NO: _____

Please Note:

All product names referred to in this manual are trademarks of their respective owners, which are in no way associated or affiliated with Line 6. These trademarks of other manufacturers are used solely to identify the products of those manufacturers whose tones and sounds were studied during Line 6’s sound model development.

You should read these Important Safety Instructions

Keep these instructions in a safe place

Before using your Spider Jam, carefully read the applicable items of these operating instructions and the safety suggestions.

1. Obey all warnings on the amp and in the Spider Jam Manual.
2. Connect only to AC power outlets rated 100-120V or 200-240V 47-63Hz (depending on voltage range of the power supply; refer to label on the unit).
3. Do not perform service operations beyond those described in the Spider Jam Manual. Service is required when the apparatus has been damaged in any way, such as:
 - power-supply cord or plug is damaged
 - liquid has been spilled or objects have fallen into the apparatus
 - the unit has been exposed to rain or moisture
 - the unit does not operate normally or changes in performance in a significant way
 - the unit is dropped or the enclosure is damaged.
4. Transformers can get hot during operation. Do not touch during operation or shortly after.
5. Do not place near heat sources, such as radiators, heat registers, or appliances which produce heat. Keep the rear of the unit at least three inches from walls or other items that might block heat radiation.
6. Do not block any of the ventilation openings or use in an enclosed space.
7. Guard against objects or liquids entering the enclosure. Do not use or place unit near water.
8. Do not step on power cords. Do not place items on top of power cords so that they are pinched or leaned on. Pay particular attention to the cord at the plug end and the point where it connects to the amp.
9. Unplug the amp when not in use for extended periods of time. Unplug the amp during lightning storms.
10. Clean only with a damp cloth.
11. Do not defeat the safety purpose of the grounding type plug. A grounding type plug has two blades and a third grounding prong. The third prong is provided for your safety. When the provided plug does not fit into your outlet, consult an electrician for replacement of the obsolete outlet.
12. Only use attachments/accessories specified by the manufacturer.
13. Prolonged listening at high volume levels may cause irreparable hearing loss and/or damage. Always be sure to practice “safe listening.”

Table of Contents

Tutorials	1•1
Tutorial 1 – Jam with a Song	1•1
Tutorial 2 – Record & Overdub with Drums.....	1•2
Tutorial 3 – Record & Play with FBV Foot Controller	1•4
Tutorial 4 – Connect a Mic to the XLR Input	1•6
Tutorial 5 – Using the Aux Input	1•7
Controls & Connections	2•1
Spider Jam the Amp	3•1
Recalling Amp Presets	3•1
Saving Presets.....	3•2
Aux Input Assign.....	3•3
Guitar Noise Gate.....	3•3
Guitar Distortion Boost	3•4
Guitar Tuner.....	3•4
FX Auto Select.....	3•4
Microphone Trim Knob	3•5
Microphone, Aux, and CD/MP3 Input Levels.....	3•5
Mic/Aux FX Presets	3•6
Mic/Aux EQ.....	3•6
Mic/Aux Reverb & Delay	3•7
Mic/Aux Compressor	3•7
Jamming with Spider Jam	4•1
Loading Drum Grooves.....	4•1
Loading Songs	4•1
Play Preview	4•2
Endless Play.....	4•2

Setting the Band/Drum Playback Level	4•3
Changing the Speed/Pitch of a Song or Drum Groove.....	4•3
Setting Guitar Tones with Songs.....	4•4
Output Routing for RCA Jacks.....	4•4
Setting the FBV Mode.....	4•5

Loop Recording with Spider Jam 5•1

Loop Recording 101	5•1
Recording without a Song or Drum Groove.....	5•2
Recording with a Song or Drum Groove	5•2
Quick Capture.....	5•3
Undoing the Last Recording.....	5•3
Clearing (Erasing) the Current Track.....	5•3
Saving Recordings.....	5•3
Loading Recordings.....	5•4
Setting the Recorder Playback Level.....	5•4
Setting the Recorder Overdub Level.....	5•5
Erasing Recordings	5•5

Appendix A: Modeled Amps..... A•1

Which Amps Are Modeled?.....	A•1
------------------------------	-----

Appendix B: Using Your Feet B•1

FBV Cable	B•1
FBV Express	B•2
FBV Shortboard	B•4

TUTORIALS

Tutorial I – Jam with a Song

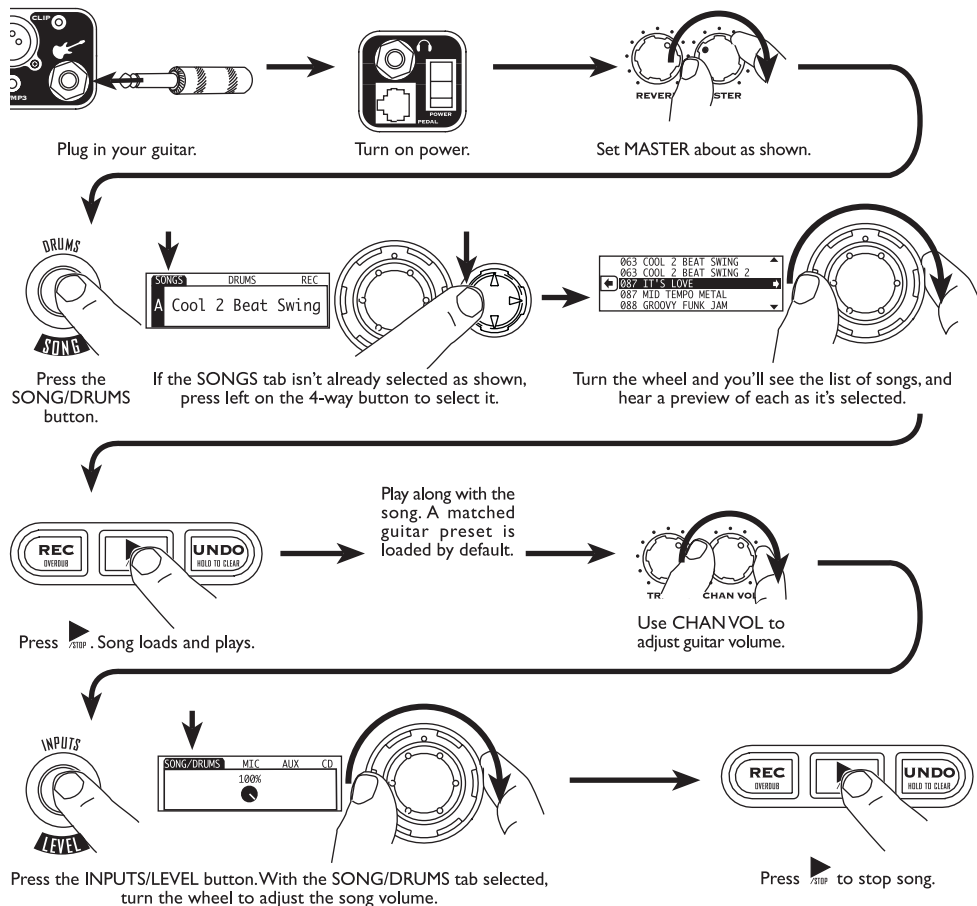

You can also jam with Drums. Give it a try!

Tutorial 2 – Record & Overdub with Drums

1•2

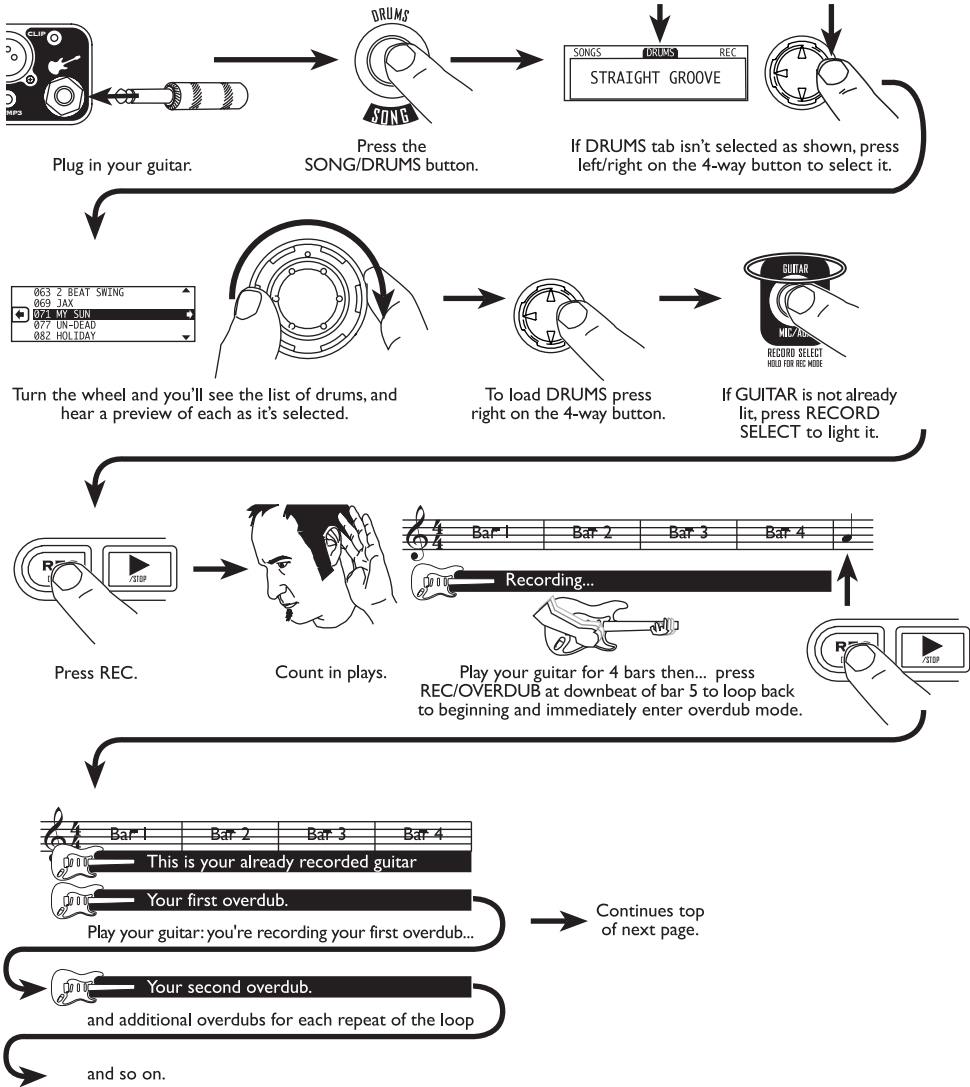

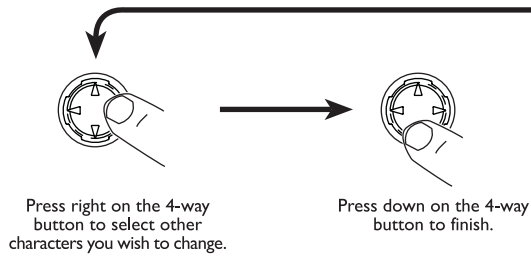
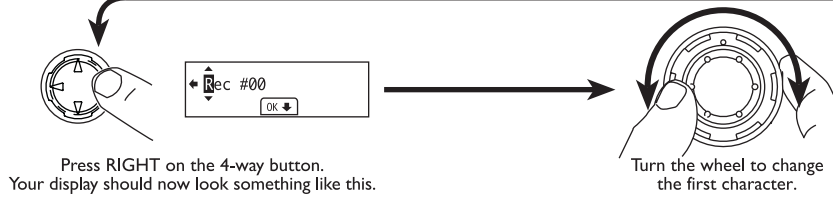
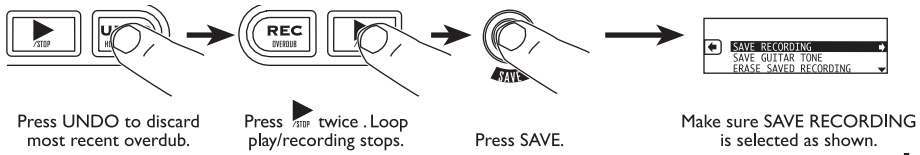

Tutorial 3 – Record & Play with FBV Foot Controller

1•4

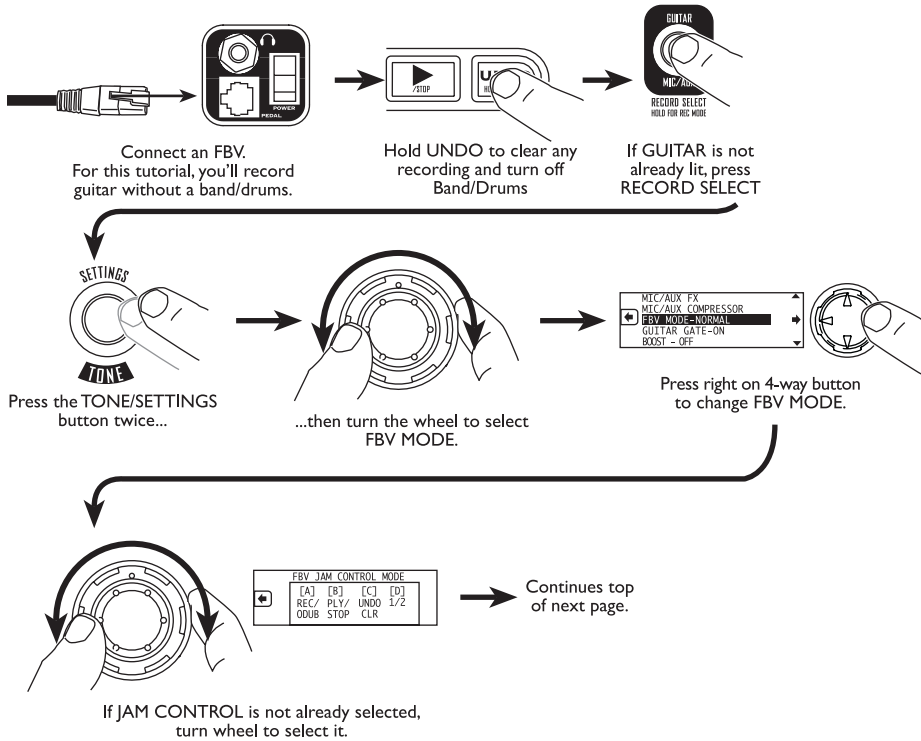

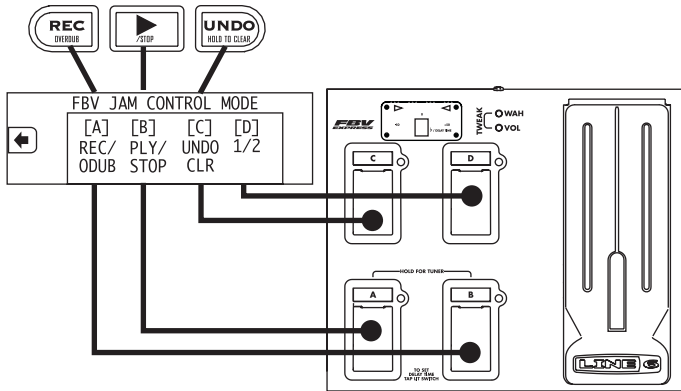

The FBV's footswitches will control record & playback features as shown above.

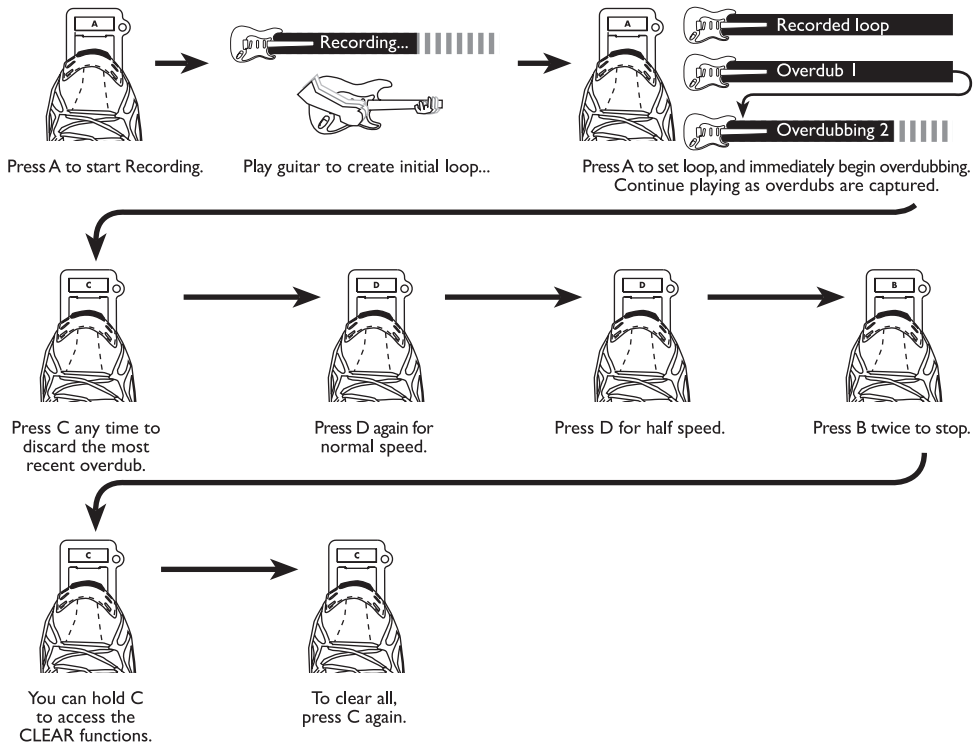

Tutorial 4 – Connect a Mic to the XLR Input

1•6

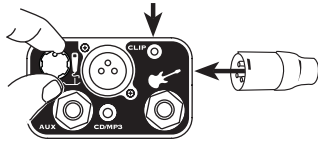

Connect your mic to the XLR input. Increase mic TRIM. Decrease if clipping.

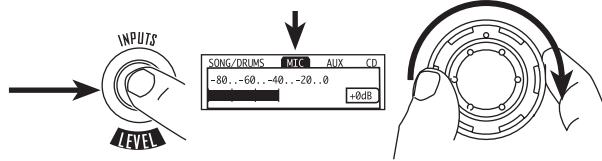

Press LEVEL/INPUTS button. Press left/right on the 4-way button to select MIC tab. Turn the wheel to balance Mic Level.

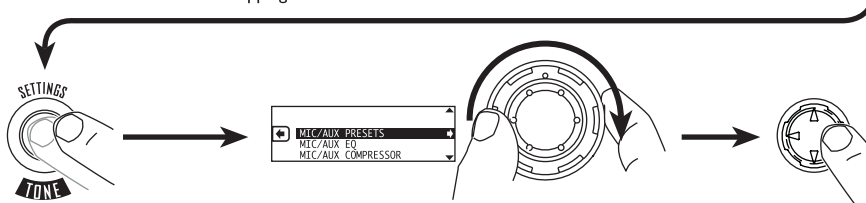

Press TONE/SETTINGS button twice to show more functions.

If MIC/AUX PRESETS isn't already selected, turn the wheel to select it.

Press right on 4-way button.

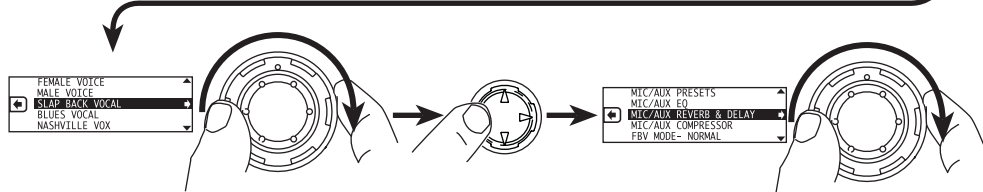

Turn the wheel to select a vocal preset.

Press left on 4-way button to return to function list.

Turn wheel to select MIC/AUX REVERB & DELAY

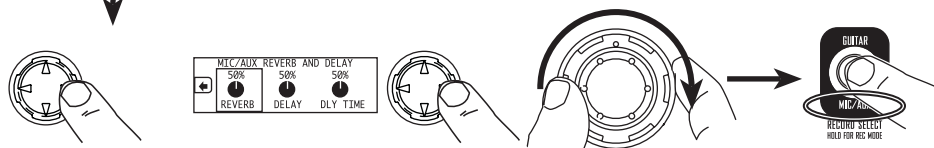

Press right on 4-way button to see the reverb and delay settings.

Press left/right on 4-way button to select values, and turn wheel to adjust them.

If you want to record your mic, press RECORD SELECT until MIC/AUX is lit.

Pop quiz: Follow the steps for recording as described earlier and create your first ever vocal harmony loop.

Tutorial 5 – Using the Aux Input

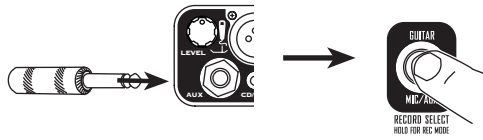

Use the AUX input for a second guitar, bass, keyboard, drum machine, etc.

Hold RECORD SELECT for two seconds.

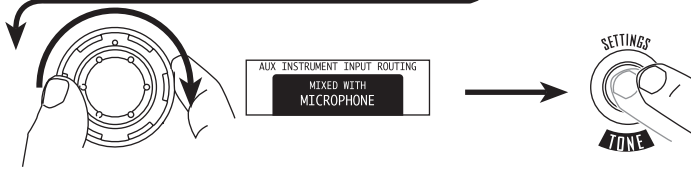

Turn wheel to select MIC if not already selected.

Press TONE/SETTINGS button twice to show more functions.

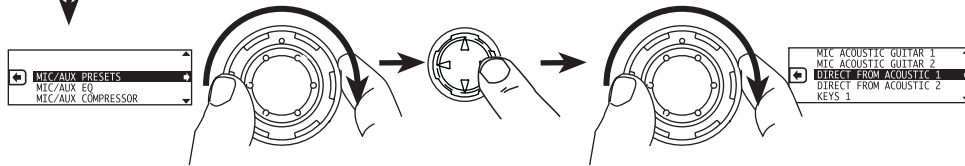

Turn wheel to Select MIC/AUX PRESETS.

Press right on 4-way button.

Turn wheel to select a preset.



Press right on 4-way button to dismiss display.

If you want to record the AUX input, press RECORD SELECT to light the MIC/AUX light if not already lit.

CONTROLS & CONNECTIONS

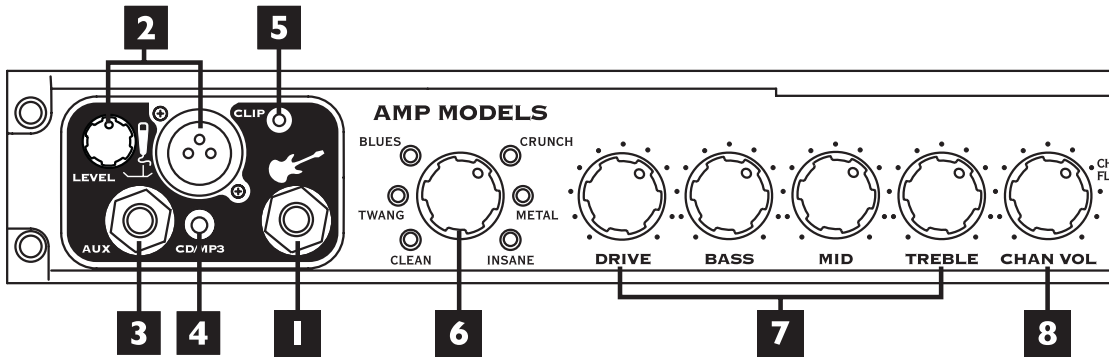

2•1

1 Guitar In – Plug your guitar in here. The Guitar input has dedicated Amp and FX processing.

2 Mic In and Trim – Connect a microphone to this XLR input and use the **Trim** knob to adjust its gain. The Mic input has its own independent EQ, Reverb, Delay and Compressor FX processing.

3 Aux In – This 1/4-inch input can be used for a second guitar, mic or just about any other audio source. You can choose whether this input gets processed and recorded with the **Guitar** input or **Mic** input.

4 CD/MP3 – Plug in any audio source to jam with your favorite music or drum machine. Use the device’s output control to adjust its volume. Note: Start with the volume on your device at it’s lowest setting and bring it up to the volume you desire.

This input get mixed with the **Mic** input for recording, but without any processing.

5 Clip Light – This lights to say, “Whoa, Nelly! That’s too much input!” If the **Guitar** and **Aux** inputs cause clipping, turn down the device that’s feeding your Spider Jam. If the **Mic** input causes clipping, turn down the **Mic Trim**.

6 Amp Models – Spin this knob to select one of (12) Amp Models. All the guitar tone and FX controls will automatically be set to sound great with that Amp Model, so you can just play! When you turn this knob, the **Display** will briefly show the currently-loaded Amp Model name, along with the current settings of the **Drive**, **Bass**, **Mid**, **Treble**, and **Chan Vol** knobs.

7 Tone Controls – Drive is like the volume or gain knob on other amps; controls how much “dirt” you get in your sound. **Bass, Mid,** and **Treble** controls are customized for each Amp Model to give you optimal tonal control. When you turn any of these knobs, the **Display** will briefly show the currently-loaded Amp Model name, along with the current settings of the **Drive, Bass, Mid, Treble,** and **Chan Vol** knobs.

8 Channel Volume – This control helps you balance the volumes of different amp-and-effect setups that you store in your Spider Jam’s (36) User preset channels. When you turn this knob, the **Display** will briefly show the currently-loaded Amp Model name, along with the current settings of the **Drive, Bass, Mid, Treble,** and **Chan Vol** knobs.

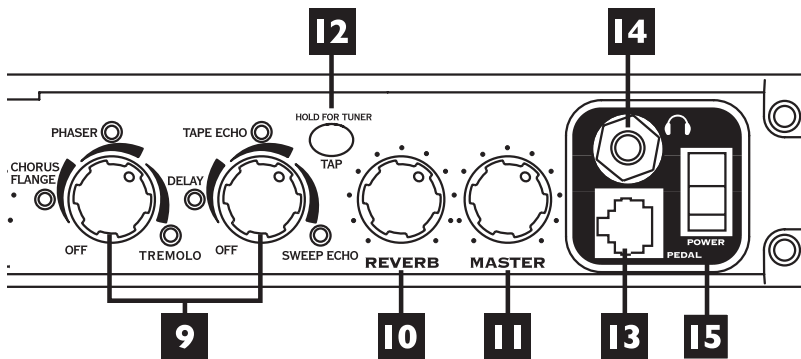

9 Smart Control FX – Spin one of these knobs to get great FX, fast and easy:

Knob A picks Chorus/Flange, Phaser or Tremolo, with a range of settings – from subtle to extreme – for each effect. The LED shows the active effect. Turning the knob all the way down turns this effect off.

Knob B picks Delay, Tape Echo or Sweep echo, with a range of mix settings from low to high. The LED shows the active effect and the **Tap** LED flashes the delay time. To change the delay time, tap the **Tap** button. Turning this knob all the way down turns the effect off.

When you turn either knob, **Display** will briefly show you the current settings.

10 Reverb – Dial up more or less virtual room. While turning the knob, the **Display** will show you the current setting.

11 Master Volume – You can choose the overall volume of the amplifier, without affecting your tone. The current setting is shown on the **Display** when you turn this knob, too.

12 Tap / Hold for Tuner – Tap on the **Tap** button a few times to set the delay time. The **Display** will briefly show the delay time you tapped in BPM (beats per minute).

Hold the **Tap** button for 3 seconds to activate the built-in chromatic tuner.

13 FBV Pedal – Plug in an optional Line 6 FBV foot controller and control Spider Jam with your feet. There are two FBV Modes of operation. Normal Mode gives you the standard features as labeled on your FBV. Jam Control Mode reassigns the ABCD footswitches of your FBV to control recorder/song/drum playback and recording. See page 4•5 for more info.

14 Phones – To listen with headphones, plug in here. The speakers are muted when this jack is in use.

15 Power Switch – Flip the switch to bring Spider Jam to life.

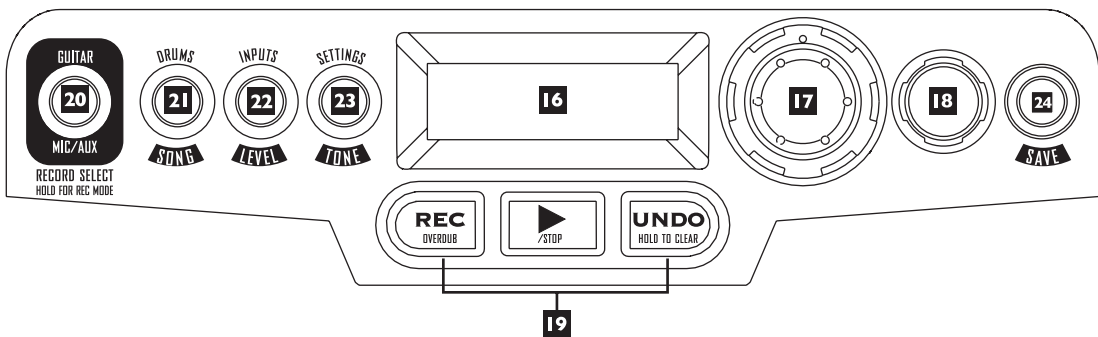

16 Display – The LCD (*liquid crystal display*) is your window into the power of Spider Jam. Here, you’ll see various “pages” as you work the controls.

17 Select Knob – Turn this knob to change the selected item on the **Display**.

18 4-way Navigation Button – Press **Up**, **Down**, **Left**, and **Right** on this button to get to a setting that you’d like to change.

19 Transport Controls – These buttons control the built-in jam and recording functions:

- **Rec/Overdub** – Press to start recording or overdubbing.
- **Play/Stop** – Press to start and stop the loaded Song, Drum Loop or Recording.
- **Undo/Hold to Clear** – After recording, press to undo (delete) your last recorded section or hold for 3 seconds to erase the entire recording.

20 Record Select Button and LEDs – Press this button to select an input for recording, either **Guitar** or **Mic/Aux**. The **Display** and corresponding text will light up to show what's been selected.

Press and hold for 2 seconds to choose whether the Aux should feed the guitar tone and get recorded with guitar, or feed the Mic FX and get recorded with the mic.

21 Song / Drums – A first press of this button gives you:

- Song Select
- Drums Select
- Recording Select
- A second press gives you:
 - Endless Play On/Off
 - Speed/Pitch Adjust
 - Play Preview On/Off

22 Level / Inputs – A first press of this button gives you:

- Song/Drums Volume
- Mic Input Level
- Aux Input Level
- CD Input Level
- A second press gives you:
 - Recorder Playback Level

- Recorder Overdub Level
- Aux Input Routing

23 **Tone / Settings** – A first press of this button gives you:

- Artist Presets
- Style Presets
- User Presets
- A second press gives you:
 - Mic Presets
 - Mic/Aux EQ
 - Mic/Aux Reverb & Delay
 - Mic/Aux Compressor
 - FBV Mode
 - Gate On/Off
 - Boost On/Off
 - FX Auto Select
 - Songs Set Guitar Tone
 - Songs Set Mic FX
 - Output Routing

24 **Save** – Pressing this button allows you to:

- Save Recording
- Save Guitar Tone
- Erase Recordings
- Upgrade firmware

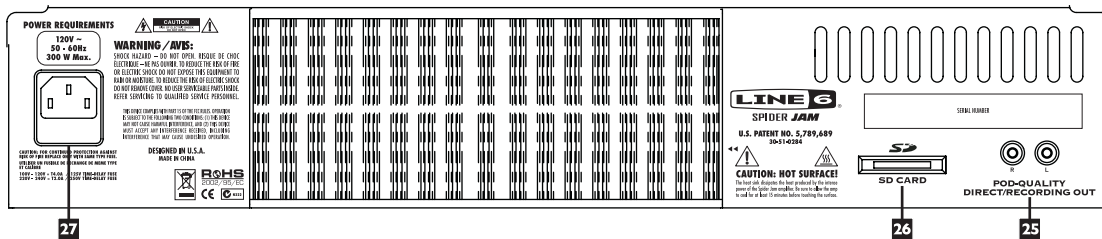

25 Direct/Recording Out – This pair of RCA jacks is perfect for connecting Spider Jam to an external recorder or computer to capture your jams. Or, connect them to your sound system to hear Spider Jam through it.

26 SD Card Slot – This slot is used at our factory to install the firmware that controls your Spider Jam.

27 Power Connector & Fuse – The included power cable connects here. See the rear panel markings for fuse information.

SPIDER JAM THE AMP

Recalling Amp Presets



Your new Spider Jam amplifier is loaded with over 300 amp-and-effect presets to cover a wide range of tones and styles. Many presets have been dialed-in by some of today's influential artists! Of these presets, there are 36 User preset locations that you can use to store your own custom tones.

With so many presets, we had to come up with a convenient way for you to browse through them all. So, the presets have been split up into the following categories.

- **Artist** – These presets were dialed-in by a team of insane guitar slinging rock stars that cover a great range of styles. We sent an amp to each of them to create a bank of inspiring tones. Some chose to capture the tone of their records, while some explored the insane range of tonal possibility that Spider Jam offers. Whatever the outcome, their work is at your disposal. It's as if they came to your home and helped you dial in your amp!

There are separate “folders” for each artist. These presets cannot be erased, but they can be modified and saved to one of the 36 User preset locations.

- **Style** – Presets organized by style or song, including based on the top 200 guitar rock songs of all time. There are separate folders for each style and year that the song came out. These, too, are read-only and cannot be erased, but can be modified and saved to one of the 36 User presets.
- **User** – 36 great-sounding presets that you can overwrite with your own custom tones. The User presets are numbered 1A - 9D and can also be recalled using an optional FBV foot controller. Check out the Appendix for more info. A factory reset (see page 3•2) will restore these presets to their factory defaults.

To recall a preset, do the following:

- Press the **Tone / Settings** button to show the Tone Page.
- Press **Left/Right** on the **4-way** button to select *Artist*, *Style*, or *User*.
- Turn the **Select** knob to select the next/previous preset from the current folder.
- To select a different folder, press **Left** on the **4-way** button, and turn the **Select**

Aux Input Assign

The **Aux** input can be used for a second guitar or any other audio source. This input can either share the Amp and FX processing with the **Guitar** input, or share the **Microphone** input's EQ, Reverb, Delay and Compressor FX. You get to decide. If you're connecting a second guitar, you'll want to share the Guitar processing. For just about everything else, you'll want to share the Microphone processing. Here's how you make that choice:

- Hold the **Record Select** button for two seconds.
- Turn the **Select** knob to select *Mixed with Microphone* or *Mixed with Guitar*.
- Press the **Song / Drums, Level / Inputs** or **Tone/Settings** button to exit.

3•3

Guitar Noise Gate

Spider Jam includes a built-in Noise Gate, which helps to cut down on hiss and noise. Here's how you turn it on and off:

- Press the **Tone / Settings** button twice to show additional functions.
- Turn the **Select** knob to highlight *Guitar Gate*.
- Press **Right** on the **4-way** button.
- Turn the **Select** knob to turn the Noise Gate on or off.

This setting is stored and recalled with presets.

Guitar Distortion Boost



There's also a Distortion Boost available. This gives the kind of extra 'dirt' that you'd expect from a Distortion pedal with the distortion control set low and the output control set high. It boosts your guitar signal before it reaches the Amp Model, so that you hit the model harder and get a more distorted sound. Enabling this is the same as kicking on Stomp on the FBV Shortboard.

- Press the **Tone / Settings** button twice to show additional functions.
- Turn the **Select** knob to highlight *Boost*.
- Press **Right** on the **4-way** button.
- Turn the **Select** knob to turn the Distortion Boost on or off.

This setting is stored and recalled with presets.

Guitar Tuner

Press and hold the **Tap** button (or **Tap** footswitch on an optional FBV footswitch) for 2 seconds or more and you get instant digital tuner. The volume is muted during tuning so you won't hear anything coming out of the amp. Press any button to exit Tuner Mode. The display on the top panel of the Spider Jam will work as the tuner display.

FX Auto Select



When you select an Amp Model from the front panel, Spider Jam will also automatically dial-in the effects to make that effect shine. If you'd like to disable this feature, you can:

- Press the **Tone / Settings** button twice to show additional functions.
- Turn the **Select** knob to highlight *FX Auto Select*.
- Press **Right** on the **4-way** button.
- Turn the **Select** knob to turn the FX Auto Select on or off.

Microphone Trim Knob

The first step after connecting a microphone is to set this knob:

- Sing into your microphone at maximum volume and turn this knob until the **Clip** light starts to light slightly.
- Turn the knob back down slightly so clipping won't occur.

Microphone, Aux, and CD/MP3 Input Levels



3•5

Before using the **Mic**, **Aux** and **CD/MP3** inputs, set their levels as follows:

- Press the **Level / Inputs** button to show the Levels Page.
- Press **Left/Right** on the **4-way** button to select *Mic*, *Aux*, or *CD*.
- Sing or play into the selected input and observe the readings on the meter.
- Turn the **Select** knob up or down until the meter shows a peak reading between -20 and 0 when you're singing or playing.

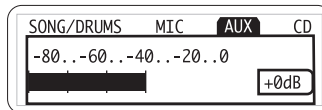

Tip: Start by turning the **Select** knob until you see +0 dB (as shown above) on the screen. Then, turn whatever is connected to Spider Jam up or down to get a peak meter reading between -20 and 0. If you can't get there from the other unit, use the **Select** knob as described above.

Mic/Aux FX Presets



The **Microphone** input has its own FX. If you've chosen to mix the **Aux** input with the **Microphone** input (see page 3•3), the **Aux** input will share this processing, too. To select a preset for these FX:

- Press the **Tone / Settings** button twice to show additional functions.
- Turn the **Select** knob to highlight *Mic FX*.
- Press **Right** on the **4-way** button to see the available presets.
- Turn the **Select** knob to select from the presets.

Mic/Aux EQ



If you'd like to customize the Mic/Aux EQ yourself:

- Press the **Tone / Settings** button twice to show additional functions.
- Turn the **Select** knob to highlight *Mic/Aux EQ*.
- Press **Right** on the **4-way** button.
- Press **Left/Right** on the **4-way** button to select *Lo*, *Mid*, or *Hi*.
- Turn the **Select** knob to adjust what you've selected.

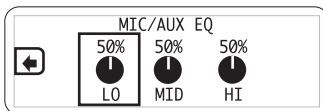

Mic/Aux Reverb & Delay



If you'd like to customize the Mic/Aux Reverb & Delay:

- Press the **Tone / Settings** button twice to show additional functions.
- Turn the **Select** knob to highlight *Mic/Aux Reverb & Delay*.
- Press **Right** on the **4-way** button.
- Press **Left/Right** on the **4-way** button to select *Reverb Level*, *Delay Level*, or *Delay Time*.
- Turn the **Select** knob to adjust what you've selected.

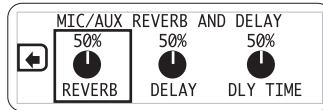

Mic/Aux Compressor



The Compressor will help even out your performance by reducing the volume of the loudest sounds to better match the volume of the quieter sounds.

- Press the **Tone / Settings** button twice to show additional functions.
- Turn the **Select** knob to highlight *Mic/Aux Compressor*.
- Press **Right** on the **4-way** button.
- Press **Left/Right** on the **4-way** button to select between *Threshold* (at what level should the compressor start working?), *Ratio* (how aggressive should the compressor be when it starts working?) and *Level* (turn it up if the compressor ends up lowering your volume too much).
- Turn the **Select** knob to adjust what you've selected.

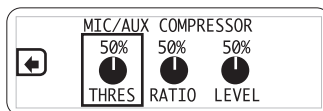

JAMMING WITH SPIDER JAM

Spider Jam is always ready to back you with over 100 built-in Songs and Drum Grooves laid down by top L.A. session aces. No MIDI here! From country to funk, and blues to punk, these authentic backing tracks are the perfect accompaniment and inspiration for practicing, composing or simply having fun playing guitar.

Loading Drum Grooves



To load a drum groove:

- Press the **Song / Drums** button to show the Song/Drums Page.
- Press **Left/Right** on the **4-way** button to select *Drums*.
- Turn the **Select** knob to see the available drum grooves. The grooves are arranged by tempo and the BPM (beats per minute) shows up as the first 3 characters of the name. If Play Preview is on, you'll hear a short clip of each drum groove as you browse.
- When you get to the one you want, press the **Play** button to play the groove and remain in the list. Or, press **Right** on the **4-way** button to play the groove and exit the list.
- Press the **Play / Stop** button to stop and start the groove. If Endless Play is set to on, the groove will play in a continuous loop. If Endless Play is set to off, the groove will play from beginning to end, then stop.

Loading Songs



To load a Song:

- Press the **Song / Drums** button to show the Song/Drums Page.
- Press **Left/Right** on the **4-way** button to select *Songs*.
- Turn the **Select** knob to see the available Songs. The Songs are arranged by tempo and the BPM (beats per minute) shows up as the first 3 characters of the Song name. If Play Preview is on, you'll hear a short clip of each Song as you browse.

- When you get to the one you want, press the **Play** button to play the Song and remain in the list. Or, press **Right** on the **4-way** button to play the Song and exit the list.
- Press the **Play / Stop** button to stop and start the Song. If Endless Play is set to on, the Song will play in a continuous loop. If Endless Play is set to off, the Song will play from beginning to end, then stop.

Play Preview



You can choose whether you want to automatically hear short clips while you browse through the Songs and Drum Grooves:

- Press the **Song / Drums** button twice to show the additional functions.
- Turn the **Select** knob to highlight *Play Preview*.
- Press **Right** on the **4-way** button.
- Turn the **Select** knob to turn Play Preview on or off.

Endless Play



You can also choose whether you want the Songs and Drum Grooves to “loop” endlessly or just play once and stop:

- Press the **Song / Drums** button twice to show the additional functions.
- Turn the **Select** knob to highlight *Endless Play*.
- Press **Right** on the **4-way** button.
- Turn the **Select** knob to turn Endless Play on or off.

Setting the Band/Drum Playback Level



- Press the **Level / Inputs** button to show the Levels Page.
- Press **Left/Right** on the **4-way** button to select *Band/Drum*.
- Turn the **Select** knob up or down to set the playback level.

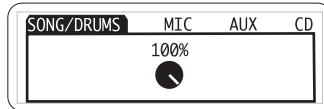

Changing the Speed/Pitch of a Song or Drum Groove



4•3

You can change the tempo of the currently-loaded Song or Drum Groove as follows:

- Press the **Song / Drums** button twice to show the additional functions.
- Turn the **Select** knob to highlight *Speed/Pitch*.
- Press **Right** on the **4-way** button.
- For Drum Grooves, the default tempo in BPM (beats per minute) will be displayed. Turn the **Select** knob to select a new tempo.
- For Songs, a transposition amount will be displayed, along with the current tempo in BPM. Turn the **Select** knob to pick a new pitch in 1/2 steps; the resulting tempo will be displayed.

Note that once you've made a recording, you can't change the speed/pitch.

Setting Guitar Tones with Songs



By default, loading a Song will automatically load a custom-crafted guitar tone, too. You can choose whether you want a Song to automatically set the guitar tone:

- Press the **Song / Drums** button twice to show the additional functions.
- Turn the **Select** knob to highlight *Songs Set Guitar Tone*.
- Press **Right** on the **4-way** button.
- Turn the **Select** knob to select *On* or *Off*.

Output Routing for RCA Jacks



You can choose what signals are sent to the RCA jacks on the back of the unit:

- Press the **Song / Drums** button twice to show the additional functions.
- Turn the **Select** knob to highlight *Output Routing*.
- Press **Right** on the **4-way** button.
- To have everything come out of both Spider Jam's on-board speakers and the RCA jacks, turn the Select knob to select *Normal*.
- To have the Guitar come out of Spider Jam's 12-inch speaker and everything else come out of the RCA jacks, turn the **Select** knob to select *Performance*.

Setting the FBV Mode



Plugging in an optional Line 6 FBV foot controller lets you control Spider Jam with your feet. There are two FBV Modes of operation. Normal Mode allows you to use your FBV for User bank and channel switching, while Jam Control Model gives you access to Transport Controls and Song selection. Depending on which FBV you choose, both modes give you access to effects on/off, distortion boost on/off, wah/volume pedals, and tap tempo for delays. A summary is below (not all functions are available from all FBVs):

FBV Footswitch	Normal Mode	Jam Control Mode
A	Tone A	Rec/Overdub
B	Tone B	Play/Stop
C	Tone C	Undo
D	Tone D	Half Speed
UP	Tone Bank Up	
DN	Tone Bank Down	
LOOP	N/A	
TAP	Delay Time	
STOMP (STOMP 1)	Dist Boost	
MOD	Mod FX On/Off	
DELAY	Delay On/Off	
REVERB	Reverb On/Off	
STOMP 2	unassigned	
STOMP 3	unassigned	
AMP 1	unassigned	
AMP 2	unassigned	
PITCH/TREMOLO	unassigned	
FAVORITE CHANNEL	unassigned	

To change the FBV mode, do the following:

- Press the **Tone / Settings** button twice to show the additional functions.
- Turn the **Select** knob to highlight *FBV Mode*.
- Press **Right** on the **4-way** button.
- Turn the **Select** knob to choose Normal Mode or Jam Control Mode.
- When Jam Control Mode is selected, the display shows you what the ABCD footswitches will do.

If you try this without an FBV connected, the display will show “No Pedal Connected”.

LOOP RECORDING WITH SPIDER JAM

Loop Recording 101

Spider Jam's on-board loop recorder allows you to record your guitar (or any other input), automatically loop that recording, and overdub into that recorded loop. You can also think of it graphically:

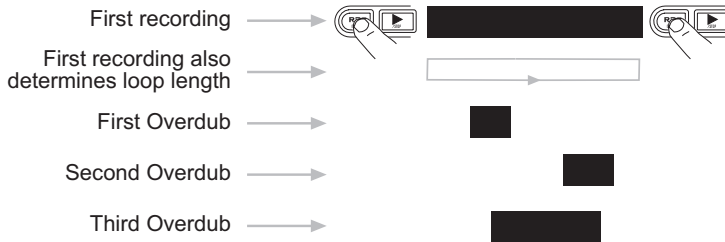

With Spider Jam, you can also loop record with or without a Song or Drum Loop. If you record with a Song or Drum Groove:

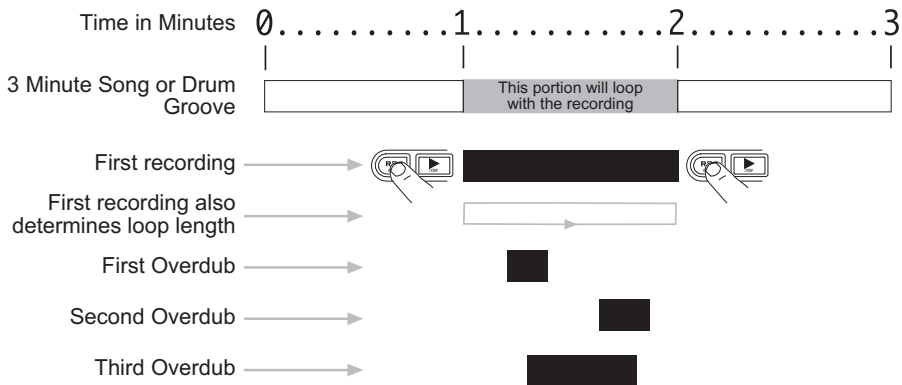

As the recording loops, the portion of the Song or Drum Groove that matches the recording will loop, too, as if it had been recorded with the loop.

Recording without a Song or Drum Groove

To record without a Song or Drum Groove:

- Press the **Song / Drums** button to show the Song/Drums page.
- Press **Right** on the **4-way** button to select **Rec**.
- Make sure your sources are connected and your levels are set as described in Chapters 3 and 4.
- Press the **Record Select** button to choose *Guitar* or *Mic/Aux* as your recording source. Remember that the Aux input can be assigned to either Guitar or Mic (see page 3•3) and the CD/MP3 input gets mixed and recorded with the Mic input.
- Press the **Rec / Overdub** button to set the loop start point and start recording.
- Play or sing.
- Press the **Rec / Overdub** button to set the loop end point, loop back to the loop start point, and immediately begin overdubbing.
- Or, press the **Play / Stop** button to set the loop end point and loop back to the loop start point in Play mode.
- Or, press the **Play / Stop** button twice to stop recording.

Recording with a Song or Drum Groove

To record with a Song or Drum Groove:

- Press the **Song / Drums** button to show the Song/Drums page.
- Press **Right** on the **4-way** button to select *Song* or *Drums*.
- Make sure your sources are connected and your levels are set as described in Chapters 3 and 4.
- Press the **Record Select** button to choose *Guitar* or *Mic/Aux* as your recording source. Remember that the Aux input can be assigned to either Guitar or Mic (see page 3•3) and the CD/MP3 input gets mixed and recorded with the Mic input.
- Load and play a Song or Drum Loop as described in Chapter 4.
- About 1 bar before you want to begin recording, press the **Rec** button. Recording

begins at beat 1 of the next bar. This will also set the loop start point.

- Play or sing.
- Press the **Rec / Overdub** button to set the loop end point, loop back to the loop start point, and immediately begin overdubbing.
- Or, press the **Play / Stop** button to set the loop end point and loop back to the loop start point in Play mode.
- Or, press the **Play / Stop** button twice to stop recording.

Quick Capture

If you've got a guitar riff that you want to capture quickly without having to set up the recorder, press both the **Rec** and **Undo** buttons at the same time to force Rec Select to Guitar, turn off the Song/Drums, and immediately start the recorder. Press **Play / Stop** to stop recording.

5•3

Undoing the Last Recording

Press the **Undo** button to erase your last overdub.

Clearing (Erasing) the Current Track

Press and hold the **Undo** button for 3 seconds to clear (erase) the current recording.

Saving Recordings



When you save a recording, your complete setup is saved, including any recorded audio, which Song is selected, your levels, Aux setup, Mic FX and guitar tone preset. To save a recording:

- Press the **Save** button.
- Turn the **Select** knob to highlight *Save Recording*.
- Press **Right** on the **4-way** button.

- Turn the **Select** knob to select the location you want to save to.
- Press **Right** on the **4-way** button.
- If you want to rename the new recording, press **Left/Right** on the **4-way** button to pick a character and the **Select** knob to change that character.
- Press **Down** on the **4-way** button to save, or press the **Song**, **Level**, or **Tone** buttons to cancel.

Loading Recordings



To load a recording:

- Press the **Song / Drums** button to show the Song/Drums Page.
- Press **Right** on the **4-way** button to select **Rec**.
- Turn the **Select** knob to see the available recordings.
- When you get to the one you want, press the **Play** button to play the Recording and remain in the list. Or, press **Right** on the **4-way** button to play the Recording and exit the list.
- Press the **Play / Stop** button to stop and start the recording.

Setting the Recorder Playback Level



You can adjust the Master (overall) playback level, as well as the playback levels of the Guitar track and Mic track:

- Press the **Level / Inputs** button twice to show the additional functions.
- Turn the **Select** knob to highlight **Recorder Playback**, then press **Right** on the **4-way** button.
- Press **Left/Right** on the **4-way** button to select **Master**, **Guitar**, or **Mic**.
- Turn the **Select** knob to set the level.

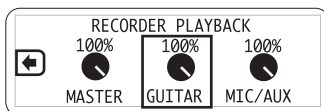

Setting the Recorder Overdub Level



You can choose how loud you want previously recorded material to be when you're overdubbing:

- Press the **Level / Inputs** button twice to show the additional functions.
- Turn the **Select** knob to highlight *Recorder Overdub*, then press **Right** on the **4-way** button.
- Turn the **Select** knob to set the level.



Erasing Recordings



To erase a recording, do the following:

- Press the **Save** button.
- Turn the **Select** knob to highlight *Erase Recording*.
- Press **Right** on the **4-way** button.
- Turn the **Select** knob to select the Recording you want to erase.
- Press **Right** on the **4-way** button.
- Press the **Down** button to erase, or press the **Song**, **Level**, or **Tone** buttons to cancel.

You can select and erase the Demo, just like any recording, to free up some additional recording time.

APPENDIX A: MODELED AMPS

Which Amps Are Modeled?

There are 12 Amp Models living within your Spider Jam.

Clean

Red LED: “Clean”. Select this Amp Model and adjust the tone controls to get crisp, amazing clean tones, great warm jazz tones, and all the high-end shimmer you’ll need with a generous amount of bottom end to boot. Then dial up a little chorus and delay to get the ultimate clean sound!

Green LED: “Glassy”. We developed this Amp Model to emulate those late 60’s and early 70’s clean tones. It started off as an Amp Model based on a 1973 Hiwatt® custom 100. We extended the tone control range and tightened up the low end. Hit an open A chord and let that big sweet tone ring!

Twang

Red LED: “Twang”. This Amp Model draws on our analysis of mid 60’s Fender® amps, including the blackface ’65 Twin Reverb® and blackface ’64 Deluxe Reverb®. We wanted an Amp Model that has that classic glassy high end tone, with some snap and bite for some serious chick’n pick’n. Things don’t get too crunchy until reaching the top range of the **Drive** knob.

Green LED: “Twin Twang”. This Amp Model is based on a number of vintage tweed amps. We evaluated a ’53 Fender® tweed Deluxe, ’58 Fender® tweed Bassman® and a ’60 Gibson Explorer to create a swingin’ Rockabilly tone. Add some reverb and a slap echo and Be-bop-*alu-la!*

Blues

Red LED: “Blues”. What would happen if we based a model on three helpings of ’65 Marshall® JTM-45, one scoop of ’58 Fender® Bassman®, a schmeer of ’63 Fender® Vibroverb and a dash of Supro for good measure? The biggest, fattest down home Blues amp ever heard. This Amp Model slides between gritty swamp-infected cleans to syrupy smooth, walloping drive tones. It’s time to get down and dirty!

* All product names are trademarks of their respective owners, which are in no way associated or affiliated with Line 6. These product names, descriptions and images are provided for the sole purpose of identifying the specific products that were studied during Line 6’s sound model development. HIWATT® is a registered trademark of Fernandes Company, Inc. FENDER®, TWIN REVERB, DELUXE REVERB, and BASSMAN are registered trademarks of Fender Musical Instruments Corporation.

Green LED: “Class A”. Ready, steady...GO! This Amp Model is based on a fawn Vox® AC-30 amplifier with an updated and expanded tone control circuit. We wanted to capture that early British pop rock tone that the Beatles and the Stones are so well known for.

Crunch

Red LED: “Crunch”. This sound was crafted during our studies of the ‘68 Marshall® Plexi 50 Watt. This type of Marshall® amp was used by a number of early metal bands. Check out albums like British Steel, Number of the Beast and Black Out. Crunch provides a wider range of tone control settings than the original Marshall® amp had. This Amp Model will allow you to bump up the mids even at the highest **Drive** settings.

Green LED: “On Fire”. Plexi On Fire! This Amp Model is based on a ‘68 Marshall® Plexi 100 watt with a few added extras; The combination of a Variac and the jumpered input channels creates that infamous brown sound that will feel like flames are shooting out the input jack! “Come on Dave... Give me a break!”

Metal

Red LED: “Metal”. This Amp Model is based on the Mesa/Boogie® Dual Rectifier®. For Spider Jam, we made careful enhancements to this classic tone. The resulting Amp Model has a definite modern flavor. This monster truck of tone delivers a tight bottom end that’s big, powerful, tight and fast. Use this Amp Model to get a tight and punchy, high gain Metal sound.

Green LED: “Spinal Puppet”. This sound was created to be an aggressive high gain Amp Model with a unique **Mid** control that will sweep through an entire spectrum of tone on one knob. The **Mid** knob for this Amp Model changes the character of the distortion. When set to minimum, the distortion exhibits Fuzz pedal characteristics. When the **Mid** is set to noon, it mimics the creamy modern high gain amp tones. And when the **Mid** knob is turned up to max, it’s very much reminiscent of that Class A sound. Of course, then there are all the places in-between...

Insane

Red LED: “Insane”. This model is our “dialed in for shredding” version of the Mesa/Boogie® Dual Rectifier® red channel. It combines the intensity and impact of Metal Red, but delivers more midrange and teeth for that bone-crushing, brain piercing insane grind.

Green LED: “80s Solo”. Our goal with Insane was to provide you with as much input gain

* All product names are trademarks of their respective owners, which are in no way associated or affiliated with Line 6. These product names, descriptions and images are provided for the sole purpose of identifying the specific products that were studied during Line 6’s sound model development. VOX® is a registered trademark of Vox R&D Limited. MARSHALL® is a registered trademark of Marshall Amplification Plc. MESA/BOOGIE® and RECTIFIER® are registered trademarks of Mesa/Boogie, Ltd.

distortion as possible short of complete meltdown. You get an obscene helping of distortion, while still retaining tonal definition and character. As a result, you get way more bottom end and cabinet character than other small amps. Crank up the **Drive** control and prepare to dominate!

APPENDIX B: USING YOUR FEET

The FBV series of foot controllers includes the original FBV, the more-compact FBV Shortboard, and the FBV Express. The following pages detail operations with the two most appropriate FBVs for Spider Jam, the FBV Express and FBV Shortboard (note that the “Line 6 Floor Board” and “FB4” foot controllers will not work with Spider Jam).

FBV Cable

FBV foot controllers come with an included RJ-45 cable. Connect this cable between the rear panel of the Spider Jam and the side of the FBV. If you ever need a replacement cable, look for a Category 5, 10 Base-T or RJ-45 cable with male connectors on both ends. These can be found at almost any computer supply retailer.

FBV Express

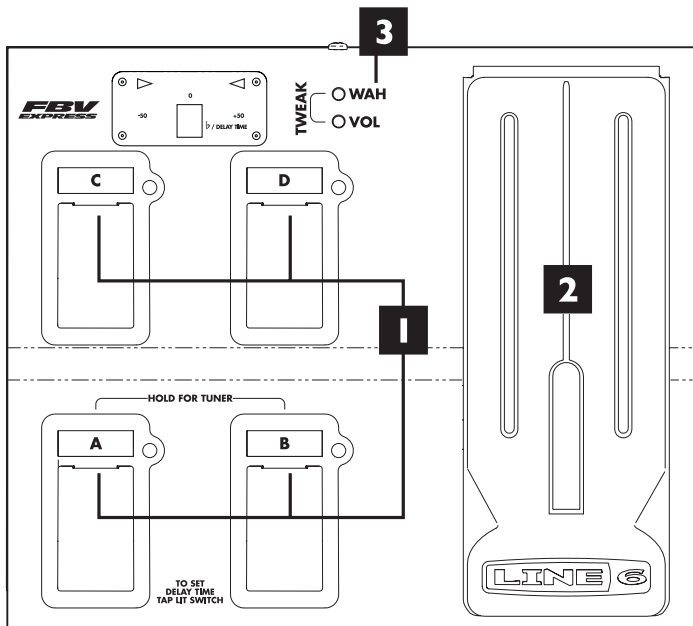

1. Channel A, B, C & D: See page 4•5. In Normal FBV Mode, these select presets and you can tap on the lit switch to set Delay Time. In Jam Control Mode, these control recorder/song/drum playback and recording.

2. FBV Pedal: Press the pedal forward to click the toe-switch, turning the pedal from Volume to Wah.

3. Wah and Volume Lights: These light to show that a pedal is ready to control Wah or Volume.

- Press the pedal fully forward to click the toe-switch, switching the pedal to control Wah or Volume.
- The Tweak function does not apply to Spider Jam.

Using your FBV Express Tuner

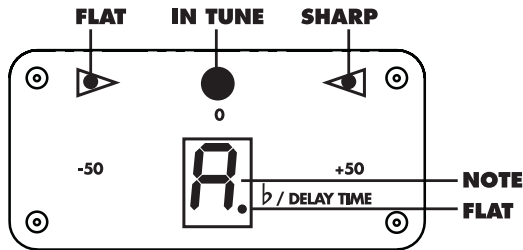
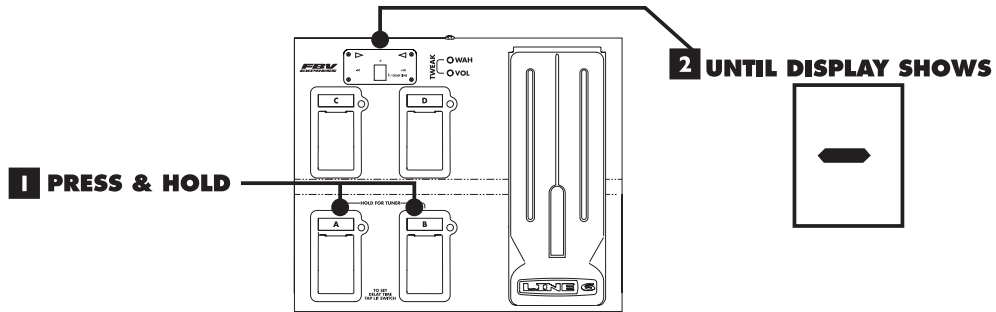

**3 DONE TUNING?
PRESS ANY OF THE A,B,C OR D FOOTSWITCHES**

FBV Shortboard

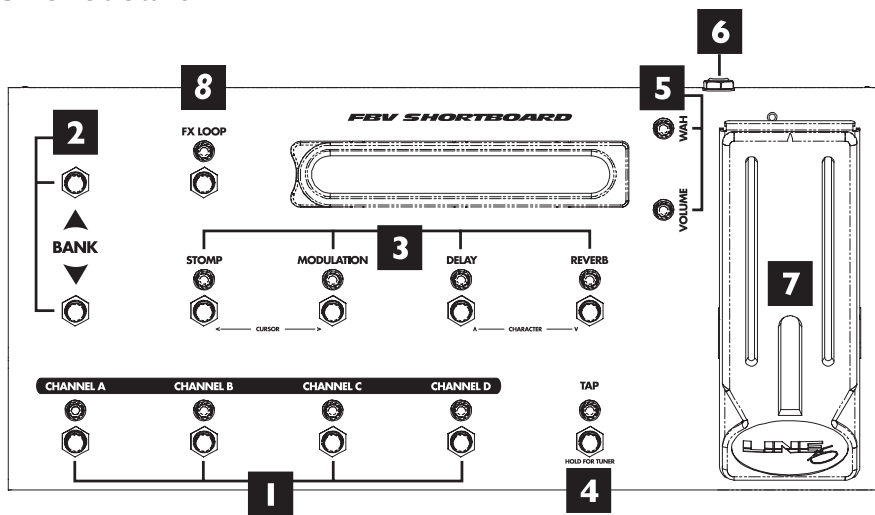

1. Channel A, B, C & D: See page 4•5. In Normal FBV Mode, these select presets and you can tap on the lit switch to set Delay Time. In Jam Control Mode, these control recorder/song/drum playback and recording.

2. Bank Up - Bank Down: Select any of the 9 Banks of User presets.

3. Stomp/Mod/Delay/Reverb: You guessed it! These switch the Spider Jam effects Mod, Delay and Reverb on and off kinda like they were stomp boxes on a pedal board. Stomp engages the Distortion Boost.

4. Tap/Tuner: Tap a couple beats to set the tempo. Or press and hold this switch until you see the tuner on the pedal's display. Press it again to exit tuner mode.

5. Wah and Volume Lights: These light to show that a pedal is ready to control Wah or Volume. Note: Pressing the pedal fully forward to click the toe-switch selects its control between Wah or Volume. If a separate expression pedal is connected to the Shortboard's rear panel 1/4-inch jack, the Shortboard pedal controls Wah only, with the toe switch toggling the Wah on/off.

6. External Pedal Jack: You can connect an expression pedal (such as the Line 6 EX-1) to the Shortboard's rear panel 1/4-inch jack, and the connected pedal will control Volume,

while the Shortboard pedal controls Wah only.

7. FBV Pedal: Press the pedal forward to click the toe-switch, turning the pedal from Volume to Wah.

8. FX Loop: Turns Spider Jam's built-in Noise Gate on and off.

