

STORMCHASER
SUPERCCELL

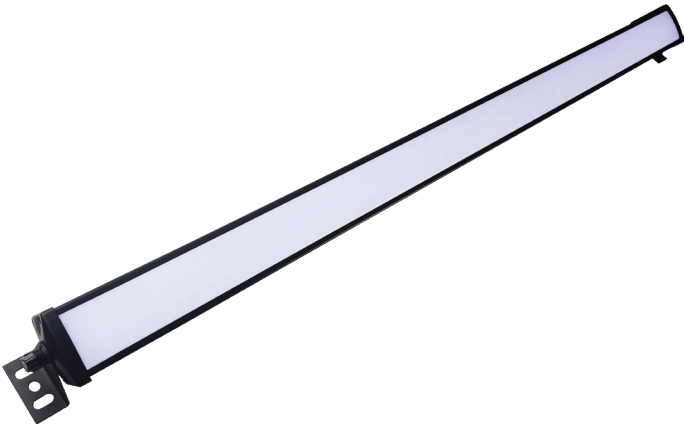

Blizzard Lighting, LLC
<http://www.blizzardpro.com>
Waukesha, WI USA
Copyright (c) 2020

TABLE OF CONTENTS

1. Getting Started	3
What's In The Box?	3
Getting It Out Of the Box	3
Powering Up!	3
Getting A Hold Of Us	3
Safety Instructions	4
2. Meet the StormChaser™ Supercell	5
Main Features	5
DMX Quick Reference (7/20/52-Channel Modes)	5
StormChaser™ Supercell Pin-Up Picture	6
The Rear Connections	6
3. Setup	7
Fuse Replacement	7
Connecting A Bunch of StormChaser™ Supercells	7
Data/DMX Cabling	7
Cable Connectors	8
3-Pin??? 5-Pin??? Huh?!?	8
Take It To The Next Level: Setting Up DMX Control	8
Fixture Linking (M/S Mode)	9
Lens Installation	9
Mounting & Rigging	9
4. Operating Adjustments	10
The Control Panel	10
Control Panel Menu Structure	11
Section Identification	11
DMX Mode	12
Starting DMX Address	12
DMX Channel Mode	12
M/S Mode	12
Auto Mode, Sound Active, & Manual Adjustments	12
Auto Programs	12
Sound Active Mode	12
Preset and Manual Colors	12
DMX Values In-Depth	13
Auto Mode Channel Values	13
5. Appendix	14
Keeping Your StormChaser™ Supercell As Good As New	14
Returns (Gasp!)	14
Shipping Issues	14
Tech Specs!	15
Dimensional Drawings	15

1. GETTING STARTED

What's In The Box?

- 1 x StormChaser™ Supercell
- 1 x PowerCON-Compatible Power Cord
- 3 x Lenses: Frosted (installed), Clear, and Opaque
- A Set of Mounting Brackets + Knobs
- This Lovely User Manual

Getting It Out Of the Box

Congratulations on purchasing one way cool, way flexible, way original LED strip light! Now that you've got your StormChaser™ Supercell, you should carefully unpack the box and check the contents to ensure that all parts are present and in good condition. If anything looks as if it has been damaged in transit, notify the shipper immediately and keep the packing material for inspection. Again, please save the carton and all packing materials. If a fixture must be returned to the factory, it is important that the fixture be returned in the original factory box and packing.

Powering Up!

All fixtures must be powered directly off a switched circuit and **cannot be run off a rheostat (variable resistor) or dimmer circuit, even if the rheostat or dimmer channel is used solely for a 0% to 100% switch.**

Warning! All fixtures must be connected to circuits with a suitable Ground (Earthing).

Getting A Hold Of Us

If something happens to go wrong, visit blizzardpro.com/support and open a support ticket. We'll be happy to help, honest.

Disclaimer: The information and specifications contained in this document are subject to change without notice. Blizzard Lighting™ assumes no responsibility or liability for any errors or omissions that may appear in this user manual. Blizzard Lighting™ reserves the right to update the existing document or to create a new document to correct any errors or omissions at any time. You can download the latest version of this document from www.blizzardpro.com.

Author:	Date:	Last Edited:	Date:
J. Thomas	8/11/2020	J. Thomas	1/18/2021

Safety Instructions



Please read these instructions carefully. They include important information about the installation, usage and maintenance of this product.

- Please keep this User Guide for future use. If you sell the unit to someone else, be sure that they also receive this User Guide.
- ALWAYS make sure that you are connecting to the proper voltage, and that the line voltage you are connecting to is not higher than that stated on the decal or rear panel of the fixture.
- This product is intended for indoor use only.
- To prevent risk of fire or shock, do not expose fixture to rain or moisture.
- Make sure there are no flammable materials close to the unit while operating.
- The unit must be installed in a location with adequate ventilation, at least 20in (50cm) from adjacent surfaces. Be sure that no ventilation slots are blocked.
- ALWAYS disconnect from the power source before servicing or replacing fuse and be sure to replace with same fuse size and type.
- ALWAYS secure fixture using a safety chain. NEVER carry the fixture by its head. Use its carrying handles.
- DO NOT operate at ambient temperatures higher than 104°F (40°C).
- In the event of a serious operating problem, stop using the unit immediately. NEVER try to repair the unit by yourself. Repairs carried out by unskilled people can lead to damage or malfunction. Please contact the nearest authorized technical assistance center. Always use the same type spare parts.
- NEVER connect the device to a dimmer pack.
- Make sure the power cord is never crimped or damaged.
- Never disconnect the power cord by pulling or tugging on the cord.
- Avoid direct eye exposure to the light source while it is on.

Caution! There are no user serviceable parts inside the unit. Do not open the housing or attempt any repairs yourself. In the unlikely event your unit may require service, please open a support ticket at www.blizzardpro.com/support.

2. MEET THE STORMCHASER™ SUPERCELL

Main Features

- Color mixing via 224x 5050RGB/0.2W LEDs
- 16 individually controllable cells
- 59 built-in auto/sound active macros w/speed control
- Auto and sound active programs via DMX
- Variable electronic strobe
- 5V USB to power SoC-It™ wireless unit (not included)
- Flicker-free (10KHz PWM) dimming
- Built-in microphone
- Dual mounting brackets
- Includes 3 lenses (frosted, opaque, and clear)

Control

- Protocol: USITT DMX-512
- DMX channels: 7/20/52-channels
- Easy-to-use 4-button control panel with LED display
- Operating modes: DMX512, M/S, auto mode, sound active, RDM

DMX Quick Reference (7/20/52-Channel Modes)

7CH	20CH	52CH	What It Does
1	1	1	Dimmer
2	2	2	Strobe
--	3-18	--	Section 1-16 Color Presets
--	--	3-50	Section 1-16 R/G/B Intensity (0% <--> 100%)
3	--	--	Red Intensity (0% <--> 100%)
4	--	--	Green Intensity (0% <--> 100%)
5	--	--	Blue Intensity (0% <--> 100%)
6	19	51	Auto Mode (chase 1-59)
7	20	52	Auto Speed (slow <--> fast) + Sound Active

StormChaser™ Supercell Pin-Up Picture

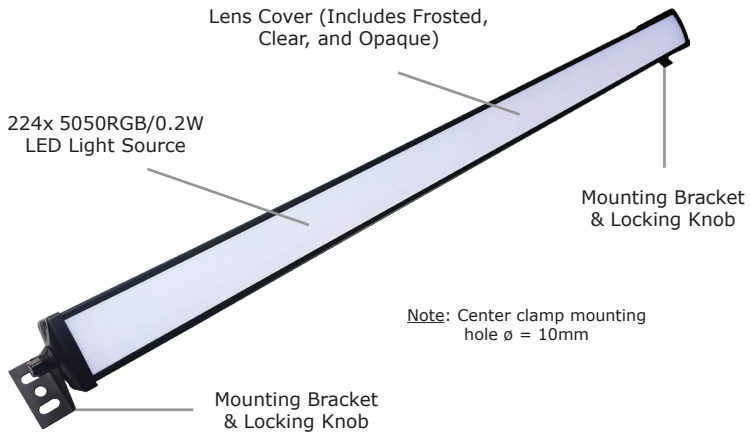

The Rear Connections

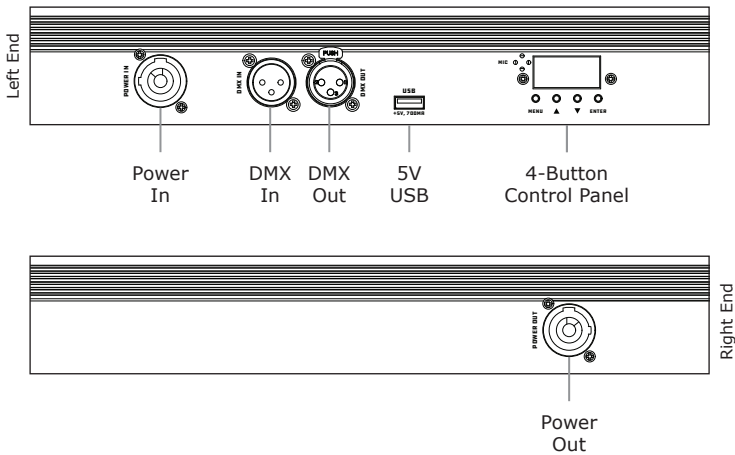

3. SETUP



Before replacing a fuse, disconnect the power cord.
ALWAYS replace with the same type and rating of fuse.

Fuse Replacement

The StormChaser™ Supercell utilizes a high-output switch-mode power supply with an internal fuse. Under normal operating conditions, the fuse should not require replacement. The fuse is field replaceable, however it is an advanced procedure suited to qualified individuals. Should the fuse require replacement, please contact Blizzard Lighting for instructions, or to return your unit for service.

Connecting A Bunch of StormChaser™ Supercells

You will need a serial data link to run light shows using a DMX-512 controller or to run shows on two or more fixtures set to sync in master/slave operating mode. The combined number of channels required by all the fixtures on a serial data link determines the number of fixtures the data link can support.

Fixtures on a serial data link must be daisy chained in one single line. Also, connecting more than 32 fixtures on one serial data link without the use of a DMX optically-isolated splitter may result in deterioration of the digital DMX signal. The maximum recommended cable-run distance is 500 meters (1640 ft). The maximum recommended number of fixtures on a serial data link is 32 fixtures.

Data/DMX Cabling

To link fixtures together you'll need data cables. You should use data-grade cables that can carry a high quality signal and are less prone to electromagnetic interference.

For instance, Belden© 9841 meets the specifications for EIA RS-485 applications. Standard microphone cables will "probably" be OK, but note that they cannot transmit DMX data as reliably over long distances. In any event, the cable should have the following characteristics:

2-conductor twisted pair plus a shield
Maximum capacitance between conductors – 30 pF/ft.
Maximum capacitance between conductor & shield – 55 pF/ft.
Maximum resistance of 20 ohms / 1000 ft.
Nominal impedance 100 – 140 ohms

Cable Connectors

Cables must have a male XLR connector on one end and a female XLR connector on the other end. (Duh!)

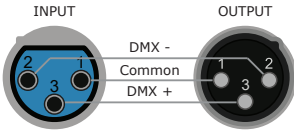

A Word on Termination:

DMX is a resilient communication protocol, however errors still occasionally occur. Termination reduces signal errors, and therefore best practices include use of a terminator in all circumstances. If you are experiencing problems with erratic fixture behavior, especially over long signal cable runs, a terminator may help improve performance.

To build your own DMX Terminator:

Obtain a 120-ohm, 1/4-watt resistor, and wire it between pins 2 & 3 of the last fixture. They are also readily available from specialty retailers.

CAUTION: Do not allow contact between the common and the fixture's chassis ground. Grounding the common can cause a ground loop, and your fixture may perform erratically. Test cables with an ohm meter to verify correct polarity and to make sure the pins are not grounded or shorted to the shield or each other.

3-Pin??? 5-Pin??? Huh?!?

If you use a controller with a 5-pin DMX output connector, you will need to use a 5-pin to 3-pin adapter. If you'd like to build your own, the chart below details a proper cable conversion:

Conductor	3-Pin Female (Output)	5-Pin Male (Input)
Ground/Shield	Pin 1	Pin 1
Data 1- (Primary Data Link)	Pin 2	Pin 2
Data 1+ (Primary Data Link)	Pin 3	Pin 3
Data 2- (Optional Secondary Data Link)	--	Pin 4 - Do Not Use
Data 2+ (Optional Secondary Data Link)	--	Pin 5 - Do Not Use

Take It To The Next Level: Setting Up DMX Control

Step 1: Connect the male connector of the DMX cable to the female connector (output) on the controller.

Step 2: Connect the female connector of the DMX cable to the first fixture's male connector (input).

Note: It doesn't matter which fixture address is the first one connected. We recommend connecting the fixtures in terms of their proximity to the controller, rather than connecting the lowest fixture number first, and so on.

Step 3: Connect other fixtures in the chain from output to input as above. Place a DMX terminator on the output of the final fixture to ensure best communication.

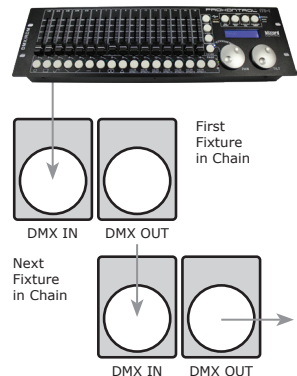

Fixture Linking (M/S Mode)

1. Connect the male connector side of the DMX cable to the output female connector of the first fixture.

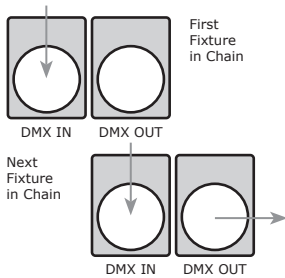

2. Connect the end of the cable coming from the first fixture which will have a female connector to the input connector of the next fixture consisting of a male connector. Then, proceed to connect from the output as stated above to the input of the following fixture and so on.

A quick note: Often, the setup for Master-Slave and Standalone operation requires that the first fixture in the chain be initialized for this purpose via either settings in the control panel or DIP-switches. Secondly, the fixtures that follow may also require a slave setting.

Check the “**Operating Adjustments**” section in this manual for complete instructions for this type of setup and configuration.

Lens Installation

To replace the lens, follow these steps:

1. Remove the locking knob, bracket, 4 screws, and end cap on either of the two ends.
2. Loosening the screws on the opposite end can allow the lens to slide easier, if needed.
3. Slide the existing lens out, and slide the replacement lens in.
4. Reinstall the end cap, 4 screws, bracket, and locking knob.

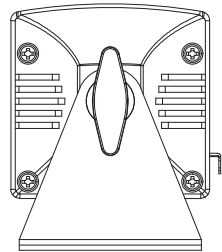

Mounting & Rigging

This fixture may be mounted in any SAFE position provided there is enough room for ventilation.

It is important never to obstruct the fan or vents pathway. Mount the fixture using a suitable “C” or “O” type clamp. The clamp should be rated to hold at least 10x the fixture’s weight to ensure structural stability. Do not mount to surfaces with unknown strength, and ensure properly “rated” rigging is used when mounting fixtures overhead.

Adjust the angle of the fixture by loosening both knobs and tilting the fixture. After finding the desired position, retighten both knobs.

- When selecting installation location, take into consideration lamp replacement access (if applicable) and routine maintenance.
- Safety cables **MUST ALWAYS** be used.
- Never mount in places where the fixture will be exposed to rain, high humidity, extreme temperature changes or restricted ventilation.

4. OPERATING ADJUSTMENTS

The Control Panel

All the features and different modes possible with the StormChaser™ Supercell are accessed by using the control panel on the rear of the fixture. There are 4 control buttons under to the LED display which allow you to navigate through the various control panel menus.

<MENU>

Is used to navigate to the previous higher-level menu item.

<UP>

Scrolls through menu items and numbers in ascending order.

<DOWN>

Scrolls through menu items and numbers in descending order.

<ENTER>

Is used to select and confirm/store the current selection.

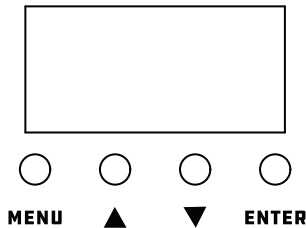

The control panel LED display shows the menu items you select from the menu map on page #11. When a menu function is selected, the display will show immediately the first available option for the selected menu function. To select a menu item, press **<ENTER>**.

Use the **<UP>** and **<DOWN>** buttons to navigate the menu options. Press the **<ENTER>** button to select the menu function currently displayed, or to enable a menu option. To return to the previous option or menu without changing the value, press the **<MENU>** button.

Control Panel Menu Structure

Addr	A001 - A512	To choose the starting DMX address
ChNd	7ch	To run in 7-channel mode
	20ch	To run in 20-channel mode
	52ch	To run in 52-channel mode
Node	NaSt	Set as master fixture
	DMX-512	DMX mode (slave)
SoUn	Su 0 - Su59	Sound active (0 = cycles 1-59)
	Se00 - Se99	Decrease/increase mic sensitivity level
Auto	Au 0 - Au59	Auto mode (0 = cycles 1-59)
	SP 1 - Sp 9	Speed adjustment (slow <--> fast)
CoLo (preset colors)	Co 1	Red
	Co 2	Green
	Co 3	Blue
	Co 4	Yellow
	Co 5	Magenta
	Co 6	Cyan
	Co 7	White
Nanu (manual colors)	Red	Red Intensity (0% <--> 100%)
	Blue	Green Intensity (0% <--> 100%)
	Green	Blue Intensity (0% <--> 100%)
dISP	<ENTER>	Display Invert
Ver	V10	Software Version

Section Identification

The table below depicts an overhead view of the StormChaser™ Supercell, and it shows the identification numbers of the 16 LED sections.

	Back								
Left	16	15	14	13	12	11	10	9	Right
	8	7	6	5	4	3	2	1	
	Front								

These sections (cells) are used with the effects in 20CH DMX mode (channels 3-18), and color mixing in 52CH DMX mode (channels 3-50).

DMX Mode

Allows the unit to be controlled by any universal DMX controller.

Starting DMX Address:

- 1.) Navigate the main menu until you reach **Addr**, and press the **<ENTER>** button. Then use the **<UP/DOWN>** buttons to select a starting DMX address ranging from 1-512, and press **<ENTER>**.

DMX Channel Mode:

- 1.) Navigate the main menu until you reach **ChNd**, and press the **<ENTER>** button. Then use the **<UP/DOWN>** buttons to select **7ch**, **20ch**, or **52ch**, and press the **<ENTER>** button to confirm.

M/S Mode:

- 1.) Daisy chain the DMX input/output connections of the fixtures.
- 2.) On the 1st fixture, navigate to **Node** and press **<ENTER>**.
- 3.) Then highlight **NaSt**, and then press the **<ENTER>** button.
- 4.) On following fixtures, this setting should be set as **DMX-512**.

Auto Mode, Sound Active, & Manual Adjustments

Allows a single or daisy chained units to run factory installed programs.

Auto Programs:

- 1.) Navigate the menu until you reach **Auto**, and press **<ENTER>**.
- 2.) Use the **<UP/DOWN>** buttons to highlight **Au 0 - Au59**, and press **<ENTER>** ("Au 0" cycles through all programs).
- 3.) Then use the **<UP/DOWN>** buttons to highlight a speed setting from **SP 1 - SP 9** (slow <-> fast).
- 4.) Press **<ENTER>**, and the program will start shortly.

Sound Active Mode:

- 1.) Navigate the menu until you reach **SoUn**, and press **<ENTER>**.
- 2.) Use the **<UP/DOWN>** buttons to Highlight **Su--** (program), or **Se--** (sensitivity), and press **<ENTER>**.
- 3.) To select a program, use the **<UP/DOWN>** buttons to select **Su 0 - Su59**, and press **<ENTER>** ("Su 0" cycles through all programs).
- 4.) To adjust mic sensitivity, use the **<UP/DOWN>** buttons to select from **Se00 - Se99** (decrease <-> increase).
- 5.) Press **<ENTER>**, and the program will start shortly.

Preset and Manual Colors:

- 1.) Navigate to **CoLo** (preset) or **Nanu** (manual), and press **<ENTER>**.
- 2.) For preset colors, highlight **Co 1 - Co 7** and press **<ENTER>**.
- 3.) For manual color mixing, adjust the **Red**, **Green**, and **Blue** intensity levels from 0-255, and press the **<ENTER>** button.

DMX Values In-Depth (7/20/52-Channel Modes)

7CH	20CH	52CH	Value	What It Does
1	1	1	000-255	Dimmer
2	2	2	000-255	Strobe
--	3	--	000-255	Cell 1
--	4	--	000-255	Cell 2
--	5	--	000-255	Cell 3
--	6	--	000-255	Cell 4
--	7	--	000-255	Cell 5
--	8	--	000-255	Cell 6
--	9	--	000-255	Cell 7
--	10	--	000-255	Cell 8
--	11	--	000-255	Cell 9
--	12	--	000-255	Cell 10
--	13	--	000-255	Cell 11
--	14	--	000-255	Cell 12
--	15	--	000-255	Cell 13
--	16	--	000-255	Cell 14
--	17	--	000-255	Cell 15
--	18	--	000-255	Cell 16
--	--	3-50	000-255	Individual Cell 1-16, R/G/B Intensity
--	--			CH Cell CH Cell CH Cell CH Cell
--	--			3 1R 15 5R 27 9R 39 13R
--	--			4 1G 16 5G 28 9G 40 13G
--	--			5 1B 17 5B 29 9B 41 13B
--	--			6 2R 18 6R 30 10R 42 14R
--	--			7 2G 19 6G 31 10G 43 14G
--	--			8 2B 20 6B 32 10B 44 14B
--	--			9 3R 21 7R 33 11R 45 15R
--	--			10 3G 22 7G 34 11G 46 15G
--	--			11 3B 23 7B 35 11B 47 15B
--	--			12 4R 24 8R 36 12R 48 16R
--	--			13 4G 25 8G 37 12G 49 16G
--	--			14 4B 26 8B 38 12B 50 16B
3	--	--	000-255	Red Intensity (0% <--> 100%)
4	--	--	000-255	Green Intensity (0% <--> 100%)
5	--	--	000-255	Blue Intensity (0% <--> 100%)
6	19	51	000-007	No Function
			008-255	Auto Mode (see table values below)
7	20	52	000-247	Auto Speed (slow <--> fast)
			248-255	Sound Active Mode

Auto Mode Channel Values (6/19/51)

Chase 1	008-011	Chase 21	088-091	Chase 41	168-171
Chase 2	012-015	Chase 22	092-095	Chase 42	172-175
Chase 3	016-019	Chase 23	096-099	Chase 43	176-179
Chase 4	020-023	Chase 24	100-103	Chase 44	180-183
Chase 5	024-027	Chase 25	104-107	Chase 45	184-187
Chase 6	028-031	Chase 26	108-111	Chase 46	188-191
Chase 7	032-035	Chase 27	112-115	Chase 47	192-195
Chase 8	036-039	Chase 28	116-119	Chase 48	196-199
Chase 9	040-043	Chase 29	120-123	Chase 49	200-203
Chase 10	044-047	Chase 30	124-127	Chase 50	204-207
Chase 11	048-051	Chase 31	128-131	Chase 51	208-211
Chase 12	052-055	Chase 32	132-135	Chase 52	212-215
Chase 13	056-059	Chase 33	136-139	Chase 53	216-219
Chase 14	060-063	Chase 34	140-143	Chase 54	220-223
Chase 15	064-067	Chase 35	144-147	Chase 55	224-227
Chase 16	068-071	Chase 36	148-151	Chase 56	228-231
Chase 17	072-075	Chase 37	152-155	Chase 57	232-235
Chase 18	076-079	Chase 38	156-159	Chase 58	236-239
Chase 19	080-083	Chase 39	160-163	Chase 59	240-255
Chase 20	084-087	Chase 40	164-167	--	--

5. APPENDIX

Keeping Your StormChaser™ Supercell As Good As New

The fixture you've received is a rugged, tough piece of pro lighting equipment, and as long as you take care of it, it will take care of you. That said, you'll need to take care of it if you want it to operate as designed. You should keep the fixture clean, especially if you are using it in an environment with a lot of dust, fog, haze, wild animals, wild teenagers or spilled drinks.

Cleaning the optics routinely with a suitable glass cleaner will greatly improve the quality of light output. Keeping the fans free of dust and debris will keep the fixture running cool and prevent damage from overheating.

In transit, keep the fixtures in cases. You wouldn't throw a prized guitar, drumset, or other piece of expensive gear into a gear trailer without a case, and similarly, you shouldn't even think about doing it with your shiny new light fixtures.

Common sense and taking care of your fixtures will be the single biggest thing you can do to keep them running at peak performance and let you worry about designing a great light show, putting on a great concert, or maximizing your client's satisfaction and "wow factor." That's what it's all about, after all!

Returns (Gasp!)

We've taken a lot of precautions to make sure you never even have to worry about sending a defective unit back, or sending a unit in for service. But, like any complex piece of equipment designed and built by humans, once in a while, something doesn't go as planned. If you find yourself with a fixture that isn't behaving like a good little fixture should, you'll need to obtain a Return Authorization (RA).

Don't worry, this is easy. Just visit www.blizzardpro.com/support and open a support ticket, and we'll issue you an RA. Then, you'll need to send the unit to us using a trackable, pre-paid freight method. We suggest using USPS Priority or UPS. Make sure you carefully pack the fixture for transit, and whenever possible, use the original box & packing for shipping.

When returning your fixture for service, be sure to include the following:

- 1.) Your contact information (Name, Address, Phone Number, Email address).
- 2.) The RA# issued to you
- 3.) A brief description of the problem/symptoms.

We will, at our discretion, repair or replace the fixture. Please remember that any shipping damage which occurs in transit to us is the customer's responsibility, so pack it well!

Shipping Issues

Damage incurred in shipping is the responsibility of the shipper, and must be reported to the carrier immediately upon receipt of the items. Claims must be made within seven (7) days of receipt.

Tech Specs!

Weight & Dimensions			
Width	42.8 in (1085 mm)		
Depth	2.6 in (66 mm)		
Height	3.3 in (82 mm)		
Weight	3.2 Lbs. (1.45 kg)		
Power			
Operating Voltage	100-240VAC, 50-60 Hz		
Power Consumption	40W		
USB	5V (700ma)		
Light Source			
LED	224x 5050RGB/0.2W LEDs		
Luminance	Clear Filter	Frosted Filter	Opaque Filter
	3,958 Nits	1,049 Nits	55 Nits
Thermal			
Max. Operating Temp.	104 degrees F (40 degrees C) ambient		
Control			
Protocol	USITT DMX-512		
DMX Channels	7/20/52-channel		
Input/Output	3-pin XLR Male/Female		
Other Operating Modes	DMX512, M/S, Auto, Sound Active		
Warranty	2-year limited warranty, does not cover malfunction caused by damage to LEDs.		

Dimensional Drawings

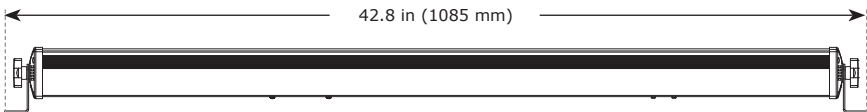
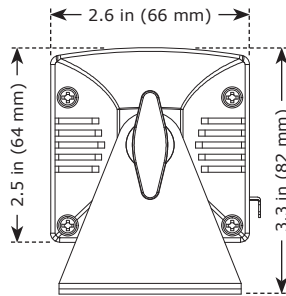

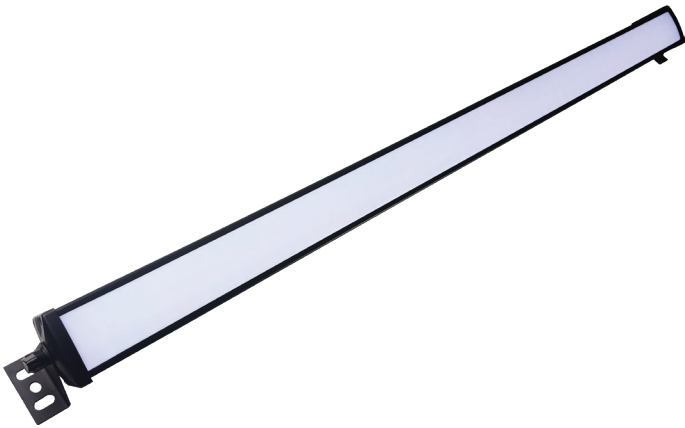

Enjoy your product!
Our sincerest thanks for your purchase!
--The team @ Blizzard Lighting