



▶▶ NEUMANN.BERLIN

## ▶ KH 750 DSP

---

ACTIVE SUBWOOFER  
WITH 2.0 / 0.1 BASS MANAGEMENT™

INSTRUCTION MANUAL





## Contents

<b>The KH 750 DSP subwoofer</b> .....	3
<b>Delivery includes</b> .....	3
<b>About this manual</b> .....	3
<b>Product overview</b> .....	4
<b>Installing and connecting the KH 750 DSP</b> .....	6
Preparing the subwoofer .....	6
Preparing the room .....	7
Setting up the subwoofers .....	7
Positioning the subwoofers .....	8
Connecting the subwoofer .....	9
Connecting network cables .....	14
Connecting/disconnecting the subwoofer to/from the mains power supply ...	15
<b>Configuring and using the KH 750 DSP</b> .....	15
Switching the subwoofer on/off .....	15
Functionality of the back panel lights .....	16
<b>AUTO STANDBY</b> switch .....	17
<b>CONTROL MODE</b> switch .....	17
Resetting the KH 750 DSP .....	17
Firmware update .....	17
Calibrating the subwoofer .....	18
Compensating for larger time of flight (TOF) differences .....	20
Using the bass management .....	20
Remote-controlling the bass management .....	21
Setting the replay level of the subwoofer .....	21
Activating ground lift .....	22
<b>Cleaning and maintaining the subwoofer</b> .....	22
<b>Troubleshooting</b> .....	23
<b>Specifications</b> .....	24
<b>Pin assignment of the XLR socket</b> .....	24
<b>Acoustical measurements and block diagram</b> .....	24
<b>Trademarks</b> .....	24
<b>Technical information &amp; glossary</b> .....	25



## The KH 750 DSP subwoofer

Thank you for purchasing a Neumann subwoofer. Neumann subwoofers are designed to complement Neumann's extensive range of monitors. They can be used in music, broadcast, and post production studios for tracking, mixing, mastering, and home recording. They can be positioned away from a wall, next to a wall or in a corner and can be mixed freely with other loudspeakers and subwoofers from the Neumann Studio Monitor Systems range.

The built-in 2.0 / 0.1 Bass Manager can be used in many ways as there are four routing modes to ensure maximum flexibility when using the subwoofer - see "Uses" below. Fourth order crossovers and flexible acoustical controls allow for seamless system integration and the bass management function can be remotely controlled.

State-of-the-art circuitry design and the specially developed long excursion bass driver have been used to ensure the most accurate sound reproduction possible. Neumann products are designed for longevity so we hope you enjoy many happy years of using this product.

### Uses

- Bass extension for loudspeakers
- Increasing the maximum SPL of loudspeakers
- Decreasing harmonic and intermodulation distortion of loudspeakers
- Reproducing the LFE channel
- Reproducing the "Sub" signal of a bass managed multichannel source
- Working as an extension for KH 810, KH 870 and KH 805 subwoofer systems
- Making a Plane Wave Bass Array™ system
- Improving the modal behaviour of the room due to optimal placement of the subwoofer in the room.

### Delivery includes

#### KH 750 DSP D G

- 1 KH 750 DSP subwoofer
- 3 Mains cables (European, UK, US version)
- 1 Quick guide
- 1 Safety guide

#### KH 750 DSP D G CCC

- 1 KH 750 DSP subwoofer
- 2 Mains cables (CCC and KC)
- 1 Quick guide
- 1 Safety guide

### About this manual

This operating manual describes the physical setup and autonomous operation of the KH 750 DSP. For information about using the KH 750 DSP in a network please refer to the very helpful Neumann.Control iPad® App.

Some of the advantages of exploring Neumann.Control are:

- More extensive acoustical controls for more accurate audio reproduction
- System-wide control such as volume control, soloing and muting
- Rapid system re-purposing

To download the App go to the Apple App Store and search for "Neumann.Control".



The current operating manual as well as the quick guide and the safety guide can also be downloaded from the "Downloads" area on the product page at [www.neumann.com](http://www.neumann.com).



Note that imperial dimensions are approximate.



## Product overview

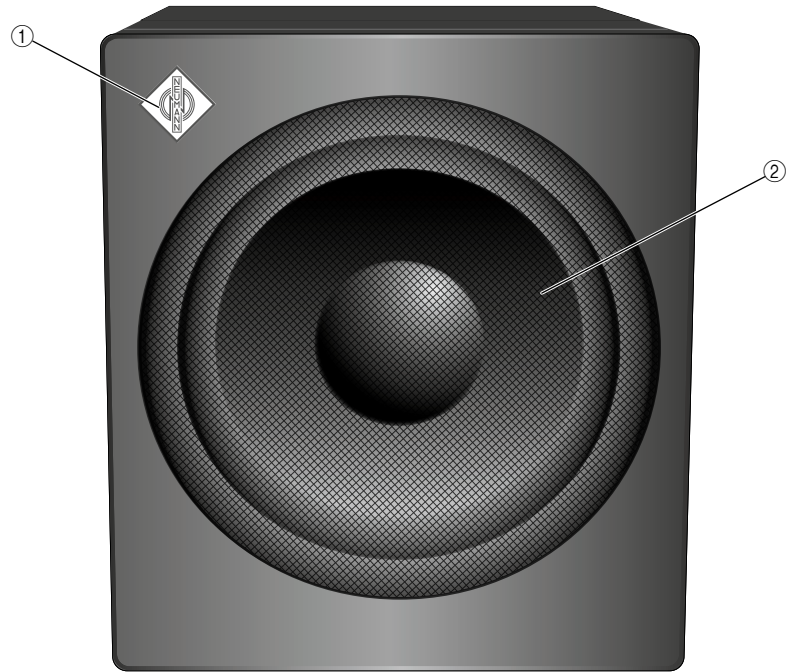

- ① Neumann logo
- ② Metal grille

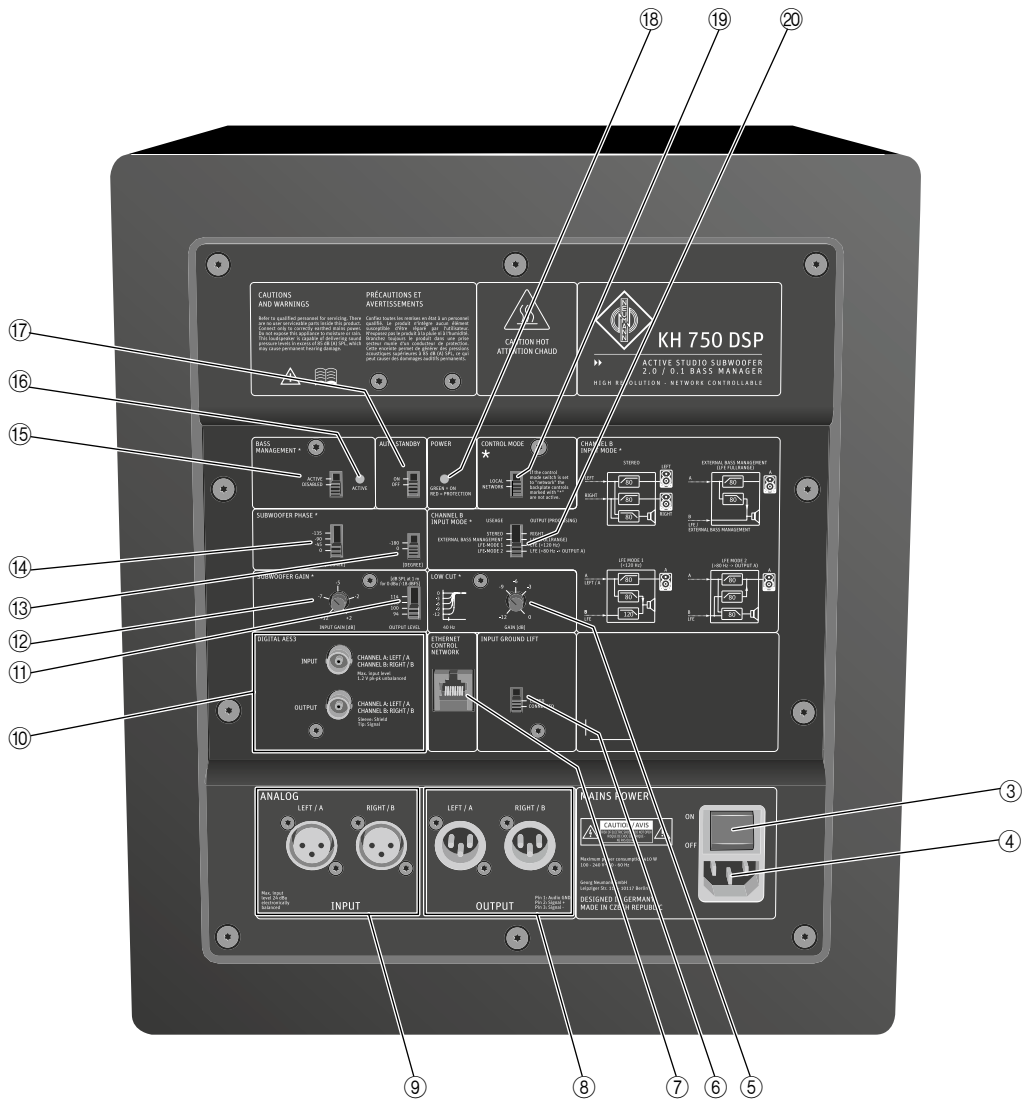

- |   |  |
|---|--|
| <ul style="list-style-type: none"> <li>③ MAINS POWER switch</li> <li>④ IEC mains socket with protective ground contact</li> <li>⑤ LOW CUT potentiometer</li> <li>⑥ INPUT GROUND LIFT switch</li> <li>⑦ ETHERNET CONTROL NETWORK socket</li> <li>⑧ XLR3-M sockets<br/>ANALOG OUTPUT   LEFT/A<br/>ANALOG OUTPUT   RIGHT/B</li> <li>⑨ XLR3-F sockets<br/>ANALOG INPUT   LEFT/A<br/>ANALOG INPUT   RIGHT/B</li> <li>⑩ BNC sockets<br/>DIGITAL   AES3 INPUT<br/>DIGITAL   AES3 OUTPUT</li> </ul> | <ul style="list-style-type: none"> <li>⑪ SUBWOOFER GAIN   OUTPUT LEVEL switch</li> <li>⑫ SUBWOOFER GAIN   INPUT GAIN potentiometer</li> <li>⑬ SUBWOOFER PHASE switch</li> <li>⑭ SUBWOOFER PHASE switch</li> <li>⑮ BASS MANAGEMENT switch</li> <li>⑯ BASS MANAGEMENT LED<br/>• green = active</li> <li>⑰ AUTO STANDBY switch</li> <li>⑱ POWER ON LED<br/>• green = on<br/>• red = protection active<br/>• amber = indication</li> <li>⑲ CONTROL MODE switch</li> <li>⑳ CHANNEL B INPUT MODE switch</li> </ul> |
|---|--|



## Installing and connecting the KH 750 DSP

Have the product installed and connected by a specialist. Due to his/her technical training, know-how and experience as well as knowledge of relevant provisions, regulations and standards, the specialist must be able to assess assigned tasks, recognize potential hazards and ensure appropriate safety measures. The following safety and mounting instructions are addressed to this specialist.



### CAUTION

Danger of injury and material damage due to tipping/dropping of the product!

If improperly mounted, the product and/or the mounting hardware (e.g. rack) can tip over or drop down.

- ▶ Always have the product mounted by a qualified specialist according to local, national and international regulations and standards.
- ▶ Use the mounting systems recommended by Neumann and always provide sufficient additional protection against tipping or dropping by means of safety wires.

### CAUTION

Damage to the product due to overheating!

If air cannot circulate properly around the rear of the subwoofer, the power amplifiers may overheat leading to premature activation of the thermal protection system which limits the maximum output level of the subwoofer. In rare cases, damage to the product may also occur.

- ▶ The whole of the back panel should have a free flow of air to ensure good cooling.
- ▶ When installing the product into tight spaces such as wall recesses, maintain an air gap of at least 2" (5 cm) around the subwoofer's backplate to ensure a free air flow.



For information on installation, please refer to the supplied "Getting Started Quickly" supplement. This will help you set up the subwoofers and loudspeakers in a way that will give you the best acoustic performance from the system. For further information on setting up subwoofers and loudspeakers, please refer to the "Questions & Answers" section at [www.neumann.com](http://www.neumann.com).

## Preparing the subwoofer

### CAUTION

Risk of staining surfaces!

Some surfaces treated with varnish, polish or synthetics may suffer from stains when they come into contact with other synthetics. Despite a thorough testing of the synthetics used by us, we cannot rule out the possibility of staining.

- ▶ Do not place the KH 750 DSP on delicate surfaces.

To place the subwoofer on a flat surface:

- ▶ Attach the supplied self-adhesive feet to the bottom of the cabinet, about 2-3 cm (1") from the edges.

This reduces the risk of scratching the surface and acoustically isolates the subwoofer from the surface.

- ▶ Alternatively, the feet can be stuck onto the side of the cabinet if that helps with mounting the product in the room.

If you want to hide the subwoofer:

- ▶ Use a thin open weave cloth. To provide visual cover, you can use two layers of the cloth.



## Preparing the room

- ▶ Arrange all acoustically relevant surfaces and objects symmetrically on either side of the listening axis of the room (left/right).
- ▶ Minimize the sound that is reflected back to the listening position by using angled surfaces and/or acoustical treatment.
- ▶ The subwoofer can deliver very low frequencies at high levels which can lead to objects and parts of the room structure to rattle. Ensure that rattling and resonating surfaces are avoided.

**i** This product has been optimized for use in recording studios. In order to avoid affecting the quality of reproduction, make sure that the product is used in an EMC environment.

## Setting up the subwoofers

### Choosing the type of setup

The driver is located on the front panel of the subwoofer, allowing the subwoofer to be either set up in a room or flush mounted into a wall recess.

Flush mounting the subwoofer into a wall recess or placing it directly against the wall offers the following advantages:

- A solid wall boosts the level of the subwoofer in the room which can be compensated by reducing the output level of the subwoofer. This also reduces distortion resulting in a cleaner sound reproduction.
- Reflections from the wall behind the subwoofer are eliminated so that the frequency response becomes smoother.
- The subwoofer does not occupy space in the room when flush mounted.

If you want to flush mount the subwoofer into a wall recess:

- ▶ Have the wall constructed by an experienced acoustical engineer. At least the following points should be observed:
  - The wall should be solid (stone, brick, concrete, several layers of gypsum or MDF).
  - Ensure a free air flow around the rear of the subwoofer.

### Using one or several subwoofers

- ▶ Use ...

one subwoofer	several subwoofers
... if your room does not offer sufficient space for several subwoofers.	... if you require a higher output power or less distortion with the same output power.
	... to suppress lateral modes or cross modes in the room by means of a Plane Wave Bass Array (PWBA™).
	... if many smaller cabinets are easier to position than one large cabinet.

**i** To reduce low-frequency distortion, the uncalibrated output level of your subwoofer should always be higher than the output level of your loudspeakers. We recommend using arrays with several subwoofers, in which case the uncalibrated maximum output level of the subwoofer array should also be higher than the maximum output level of all the loudspeakers in the system. The subwoofers can then be calibrated to a lower output level resulting in lower distortion and correspondingly cleaner low-frequency reproduction.

For information on building a balanced system, please refer to the “Product Selection Guide” at [www.neumann.com](http://www.neumann.com).

If several subwoofers are used, they must be controlled parallelly by using Y cables to feed the signals to all subwoofers.



## Positioning the subwoofers

Regardless of whether you are setting up one or several subwoofers:

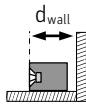

- ▶ Always ensure that the distance  $d_{wall}$  between the wall behind the subwoofer and the subwoofer's front is less than 0.8 m.

If you are setting up **one** subwoofer:

- ▶ Position the subwoofer against the front wall, left or right of the middle of the front wall ideally at 1/4 or 3/4 of the room width.
- ▶ Do not place the subwoofer at the side wall or rear wall of the room as sometimes proposed for domestic applications.

If you are setting up **several** subwoofers as a Plane Wave Bass Array™ (PWBA™):

- ▶ Use two to four subwoofers for smaller rooms and three to four subwoofers for larger rooms.
- ▶ Set up the subwoofers along the front wall within half a wavelength of the upper cut off frequency of each other. The maximum spacing of the subwoofer cabinets is determined by the setting of the routing mode or crossover frequency (see page 21):

Setting	Max. spacing of the subwoofer cabinets
RIGHT	approx. 2 m (6'6")
EXTERNAL BASS MANAGEMENT	depends on crossover frequency setting in the source equipment, for 80 Hz approx. 2 m (6'6")
LFE-MODE 1	approx. 1.4 m (4'6")
LFE-MODE 2	approx. 2 m (6'6")

If you observe the stated spacing, the subwoofers form a cylindrical source and generate a plane wave down the room, a so-called Plane Wave Bass Array™ (PWBA™). The PWBA™ reduces stationary waves between the side walls, improves the bass reproduction and suppresses lateral room resonances.

You can correct excessive low frequency energy in the room using the potentiometer SUBWOOFER GAIN | INPUT GAIN ⑫ and the switch SUBWOOFER GAIN | OUTPUT LEVEL ⑪ (cf. page 26).

### Utilizing the acoustical gain

If you set up several subwoofers, you can utilize their mutual coupling to achieve an acoustical gain. The following acoustical gains are possible:

Number of subwoofers	Acoustical gain
1	0.0 dB
2	6.0 dB
3	9.5 dB
4	12.0 dB





### Positioning and orienting subwoofers and loudspeakers

Subwoofers are omni-directional in their typical pass band as the generated wavelength is long compared to the surface producing the sound, therefore it does not matter in which direction the subwoofer is oriented when placed in the listening environment.

For your loudspeakers, however, an accurate positioning and orientation is vital.

▶ Position your loudspeakers as follows:

System	Position and orientation
2.0 (stereo)	±30°
5.1	ITU-R BS.775-1: 0°, ±30°, ±110° (±10°) (center, front left/right, surround left/right)
	ANSI/SMPTE 202M: 0°, ±22.5°, arrays to the surround left and to the surround right, plus optional subwoofer(s)
6.1	as 5.1 systems plus 180° (back center)
7.1	0°, ±30°, ±90°, ±150° (center, front left/right, side left/right, back left/right)

For detailed information on the positioning and orientation of your loudspeakers, please refer to the operating manuals of the loudspeakers.

If your subwoofers cannot be placed at the same distance from the listening position as the loudspeakers, time-of-flight differences will occur.

- ▶ Avoid distance differences of > 2 m (6'6").
- ▶ Compensate for time-of-flight differences as described in the chapter “Calibrating the phase” on page 19.

### Connecting the subwoofer

Signal (source connector)	Source impedance	Cable length	Subwoofer connection method
Analog (RCA)	low	up to 10 m (30')	via an adapter (RCA-XLR) to the ANALOG INPUT socket (XLR) ⑨ (see below)
Analog (XLR)	low	up to 100 m (300')	directly to the ANALOG INPUT socket (XLR) ⑨ (see below)
AES3 (BNC)	75 Ω	up to 100 m (300')	directly to the DIGITAL INPUT socket (BNC) ⑩ (see page 10)
AES3 (XLR)	110 Ω	up to 100 m (300')	via an impedance converter and an adapter (XLR-BNC) to the DIGITAL INPUT socket (BNC) ⑩ (see page 10)
S/P-DIF (RCA)	75 Ω	up to 10 m (30')	via an adapter (RCA-BNC) to the DIGITAL INPUT socket (BNC) ⑩ (see page 10)

The default signal selection is analog. If a valid digital signal is connected to the digital input this digital signal is automatically selected. In the Neumann.Control iPad® App it is possible to select between automatic signal switching, analog or digital.

**Note:** If the source equipment is digital, we recommend using digital connections from the source to the subwoofer as this avoids additional unnecessary signal conversions.



**Connecting analog signals to the KH 750 DSP**

- Use balanced XLR cables to connect the corresponding sockets ANALOG INPUT ⑨ of the KH 750 DSP to the audio source.

**Connecting unbalanced cables**

- Use an XLR adapter (not supplied) to connect unbalanced cables (e.g. RCA cables). Use the following wiring if you want to make your own XLR adapter:

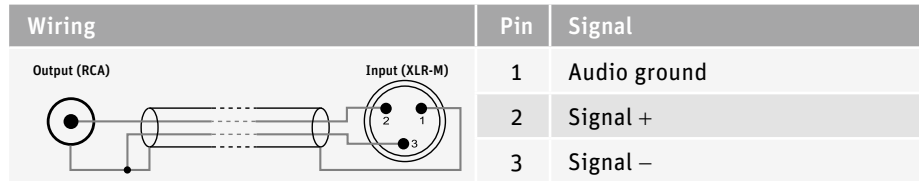

The level delivered by devices with RCA outputs (-10 dBV) is usually less than the studio level (+4 dBu):

- If necessary, use active unbalanced-to-balanced converters in order to be able to connect devices with unbalanced signals.
- We do not recommend passive unbalanced to balanced converters using transformers. They usually limit low frequency levels and increase high frequency distortion.

**Connecting AES cables**

**Connecting digital signals to the KH 750 DSP**

- Connect the digital AES3 or S/P-DIF-output signal of your audio source to the DIGITAL INPUT socket ⑩ of the respective KH 750 DSP. See picture below.

The KH 750 DSP subwoofer only supports non-encoded AES3 and S/P-DIF signals. Encoded signals such as MP3, DTS or Dolby Digital are not supported.

Only one cable is needed for uncompressed AES3 and S/P-DIF digital signals (single-wire mode). They contain two audio channels: “subframe A” and “sub-frame B”. Usually, the audio channels are:

Subframe A	Subframe B
Left	Right
Center	LFE
Surround left	Surround right
Back left	Back right

A clock input is not required because subwoofers are not audio sources and the converters are clocked to a very stable internally generated clock source.

- Use a Neutrik NADITBNC-F impedance and level converter (not supplied) for XLR to BNC conversions of AES3-signals. This method brings impedance matching, level matching and source-receiver isolation. The Neutrik NADITBNC-F converter is guaranteed to work up to 48 kHz. Only one converter is needed per digital signal cable.
- Use the following wiring if you want to make your own converter:

**CAUTION**  
Damage to the product due to high AES3 signal levels!

AES3 signal levels in XLR cables are much too high for the DIGITAL INPUT socket (BNC) ⑩. If you connect such signals without reducing the signals’ level, damage to the product will occur.

- Always make sure that your converter is able to match impedance and level.

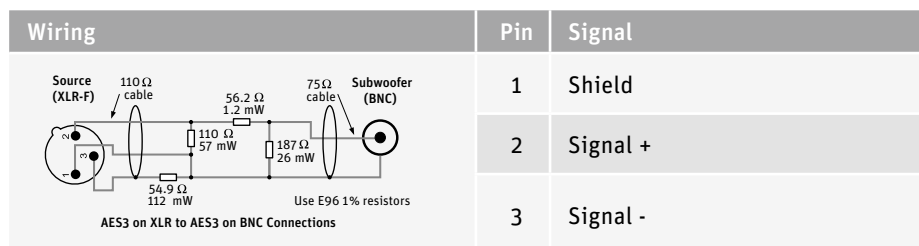

This method brings impedance matching and level matching, but no source-receiver isolation. Use a resistor network to passively attenuate the XLR signal from 3.1 V down to 0.42 V and change the impedance from 110 Ω to 75 Ω.



### Connecting loudspeakers to the subwoofer

For a simplified representation, the following connection examples show loudspeakers in combination with the KH 750 DSP subwoofer. Each of the examples only shows one possible combination of loudspeakers and subwoofers. For information on building a balanced system, please refer to the “Product Selection Guide” at [www.neumann.com](http://www.neumann.com).

Either use balanced XLR cables to connect the corresponding ANALOG OUTPUT ⑧ sockets of the subwoofer to the analog input sockets of the loudspeakers or use the DIGITAL OUTPUT ⑩ socket for loudspeakers with digital inputs.

#### Stereo systems Full range stereo (bass managed): two loudspeakers and one subwoofer

- ▶ Find the correct cabling diagram below depending on your source signal type (analog or digital) and the subwoofer/loudspeaker interconnection signal type (analog or digital).
- ▶ Set the CHANNEL B INPUT MODE switch ⑳ to STEREO.

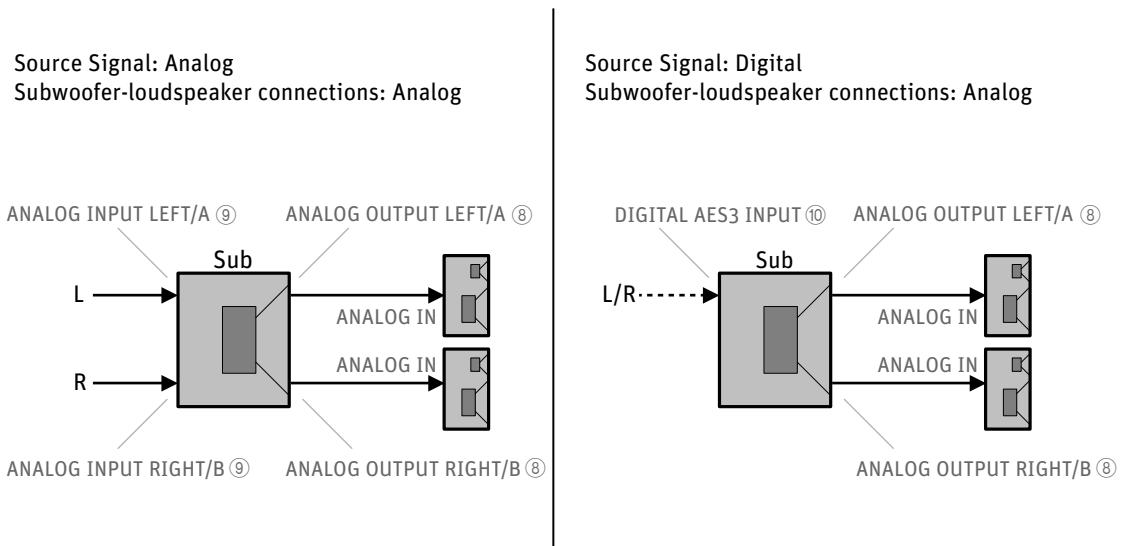



**Full range stereo (bass extension): two loudspeakers and two subwoofers**

- ▶ Find the correct cabling diagram below depending on your source signal type (analog or digital) and the subwoofer/loudspeaker interconnection signal type (analog or digital).
- ▶ Set the CHANNEL B INPUT MODE switch ⑳ to STEREO.

Source Signal: Analog  
Subwoofer-loudspeaker connections: Analog

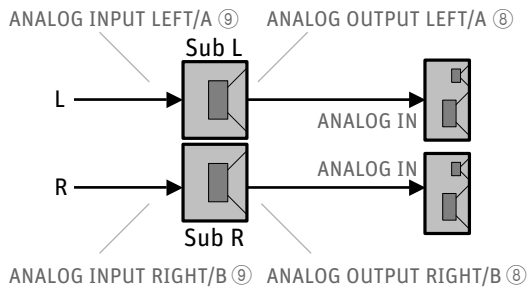

Source Signal: Digital  
Subwoofer-loudspeaker connections: Analog

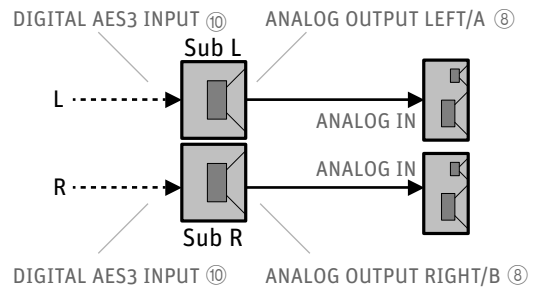



**Multichannel systems**

**Discrete multichannel systems (professional applications)**

In multichannel systems, stereo pairs of loudspeakers (L/R, Ls/Rs, etc.) can be connected to subwoofers as shown above. For all further channels proceed as follows (not supported by the Neumann.Control iPad® App).

- ▶ For the Center and Sub/LFE channels, find the correct cabling diagram below depending on your source signal type (analog or digital) and the subwoofer/loudspeaker interconnection signal type (analog or digital).
- ▶ The Center channel must be connected to the analog A input or be located on the digital A channel. The Sub/LFE channel must be connected to the analog B input or be located on the digital B channel.
- ▶ Depending on how you wish to handle the Sub/LFE channel, set the CHANNEL B INPUT MODE switch ⑳ to EXTERNAL BASS MANAGEMENT, LFE-MODE 1 or LFE-MODE 2.
  - EXTERNAL BASS MANAGEMENT replays the “Sub” channel full range through the subwoofer (preferred setting for already encoded signals or a mixing console with bass management enabled). In the source equipment, set the loudspeakers to “Small” and the crossover frequency to 80 Hz.
  - LFE-MODE 1 replays the LFE channel up to 120 Hz through the subwoofer (preferred setting for movie mixes, pre-encoded mixes).
  - LFE-MODE 2 replays the LFE channel up to 80 Hz through the subwoofer and above 80 Hz through the connected center loudspeaker, thereby giving full range monitoring for the LFE channel (preferred setting for music mixes).

Source Signal: Analog  
Subwoofer-loudspeaker connections: Analog

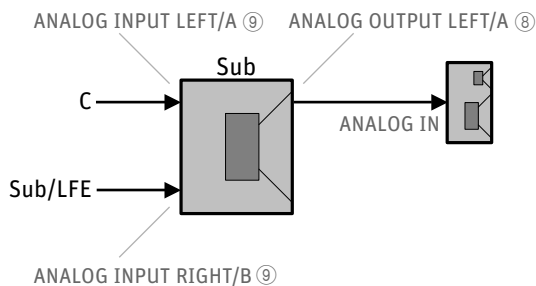

Source Signal: Digital  
Subwoofer-loudspeaker connections: Analog

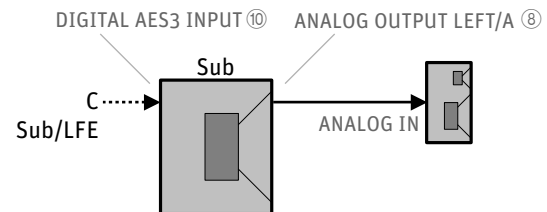



### Bass managed multichannel systems (domestic applications)

- ▶ In multichannel systems where there is a bass manager preceding the monitoring system (for example in surround sound processors), connect the loudspeakers and subwoofer(s) directly to the source equipment (analog or digital). The “Sub” signal should be connected to the analog B input or be located on the digital B channel.
- ▶ Set the CHANNEL B INPUT MODE switch ⑩ to EXTERNAL BASS MANAGEMENT.
- ▶ In the surround sound processor, set the loudspeakers to “Small” and the crossover frequency to 80 Hz.

Source Signal: Analog

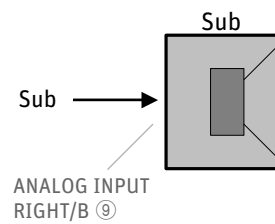

Source Signal: Digital

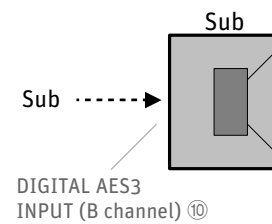

### Connecting network cables

To use the extended functionality offered by the Neumann.Control iPad® App, the subwoofer must be connected to a standard network switch using a user supplied standard Ethernet cable (Cat 5 or better). The maximum length of the cable is 100 m.

The wizard in the Neumann.Control iPad® App will guide you through the network setup procedure.

## Connecting/disconnecting the subwoofer to/from the mains power supply

To connect the KH 750 DSP to the mains power supply:

- Make sure that the switch MAINS POWER ③ is set to “OFF”.
- Connect the IEC connector of the supplied mains cable to the IEC mains socket ④.

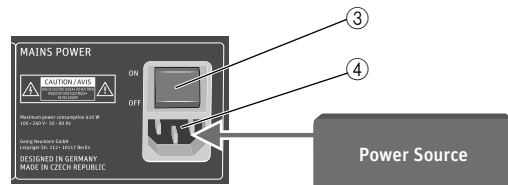

- Connect the mains plug of the mains cable to a suitable wall socket.

To disconnect the KH 750 DSP from the mains power supply:

- Set the switch MAINS POWER ③ to “OFF”.
- Pull the mains plug out of the wall socket.

## Configuring and using the KH 750 DSP

### Switching the subwoofer on/off

You can switch the KH 750 DSP on and off using the switch MAINS POWER ③.

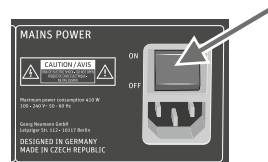

On/off switching using the switch MAINS POWER ③

- Set the switch MAINS POWER ③ to:
  - “ON” to switch the subwoofer on. The POWER ON LED ⑱ lights up red for 5 seconds, during which the subwoofer is muted (see below). The POWER ON LED ⑱ then lights up green.
  - “OFF” to switch the subwoofer off. The POWER ON LED ⑱ lights up red and goes off after a few seconds. The subwoofer mutes immediately when it is switched off.

**i** There is a five second delay before sound can be heard from the KH 750 DSP and the loudspeakers connected to the outputs in order to avoid noises (pops) from preceding equipment switched on at the same time. Conversely, switching off the subwoofer immediately mutes the audio.



## Functionality of the back panel lights

Action	Indication
<b>Firmware activities</b>	
Subwoofer is booting up	Power LED solid red
Subwoofer boot up error	Power LED flashing red
Subwoofer firmware is being updated	Power LED solid amber
Subwoofer resetting to factory default settings	Power LED flashing red
<b>Everyday operation</b>	
Operating normally	Power LED solid green
Subwoofer in active system is solo'ed in the Neumann.Control iPad® App	Power LED solid green
Subwoofer system output level is muted (GUI button on Operate page)	Power LED solid red
Subwoofer system output level is dimmed (GUI button on Operate page)	Power LED solid green
Bass management disabled	Bass management LED off
Bass management active	Bass management LED green
<b>Protection</b>	
Protection system is activated (takes priority over other indications)	Power LED red
<b>Neumann.Control iPad® App Alignment</b>	
Setup: Identify the Subwoofer	Power LED flashing amber
Guided Alignment: Subwoofer is selected	Power LED flashing amber
Manual Alignment: Subwoofer is selected	Power LED flashing amber





## AUTO STANDBY switch

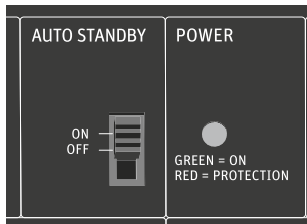

If the AUTO STANDBY switch ⑰ has been set to ON, the KH 750 DSP will switch to standby after 90 minutes without an input signal.

Standby means that the network interface, signal processing circuitry and power amplifiers are all powered down. Standby mode is automatically deactivated when a sufficiently large audio signal is detected at the input. The time taken to resume normal operation and hear sound is 5 seconds. It is possible to change the time and standby signal level before standby mode is activated using the Neumann.Control iPad® App.

Standby can be disabled by moving the AUTO STANDBY switch ⑰ to OFF.

## CONTROL MODE switch

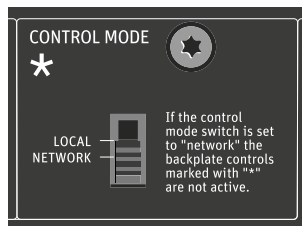

If the CONTROL MODE switch ⑲ has been set to LOCAL, the KH 750 DSP will not react to network commands from the Neumann.Control iPad® App. Control of the subwoofer will be from the backplate only.

If the CONTROL MODE switch ⑲ has been set to NETWORK, the KH 750 DSP will react to network commands from the Neumann.Control iPad® App. All backplate controls marked with “\*” will be ignored.

If the CONTROL MODE switch ⑲ is set to NETWORK but there is no network connection and active Neumann.Control iPad® App, the last used network configuration will be used. If the Neumann.Control iPad® App has not been connected before, the default settings will be used.

If you have configured any settings via the Neumann.Control iPad® App and you remove the network cable, the current settings will stay active.

By switching from network control to local control you can easily switch between a configuration set using the Neumann.Control iPad® App and settings made directly on the subwoofer.

This can make sense if you want to temporarily use the subwoofer in a different location than your measured studio environment.

The subwoofer does not lose its settings even when disconnecting it from the network or the mains supply.

## Resetting the KH 750 DSP

To reset the KH 750 DSP internal controls to their factory default values:

- ▶ Switch on the KH 750 DSP.
- ▶ While the power light is solid red during the boot up phase, move the AUTO STANDBY switch ⑰ up and down repeatedly. The power light will then flash red while the default settings are being applied before reverting to green.

## Firmware update

Firmware updates are done via the Neumann.Control iPad® App. When it is opened it surveys the network for subwoofers and checks if the firmware is up to date. If a firmware update is needed, you will be prompted to follow the on-screen instructions. It takes approximately 1.5 minutes per subwoofer to do the update.



## Calibrating the subwoofer

Before using your system for the first time and whenever you change the physical conditions in your listening environment, carry out the following steps:

- ▶ Adjust the frequency response and the level of the loudspeakers **before** calibrating the subwoofer (see the operating manual of the loudspeakers):

Application	Recommended frequency response	Comments
Studio	flat	A flat response brings good translation
Film	X-curve shape	ANSI/SMPTE 202M: the shape of the X-curve depends on the size of the room
Home	subjective evaluation	Not necessarily a flat response, a gently downward sloping response with increasing frequency is often preferred

All the loudspeakers in the system should have the same level at the listening position. This is often measured using a pink noise test signal that is set to -18 dBFS (Europe) or -20 dBFS (USA) on the mixing console's output level meters and a sound level meter set to "C-weighted" and "slow".

- ▶ Calibrate the frequency response, the phase and the acoustical level of the subwoofer. To do so, choose one of the following methods:

1. Alignment using the Neumann.Control iPad® App:  
It is highly recommended to use the Neumann.Control iPad® App to calibrate the loudspeakers and subwoofer in the room. Download the app and choose an Alignment method that suits your circumstances: Guided or Manual.
2. Calibration using the backplate controls:
  - A: Calibration using an acoustical measurement system  
Calibrating the frequency response, phase and sound pressure level by means of an acoustical measurement system should always be your first choice since it yields the highest accuracy. This method is described below.
  - B: Calibration using Neumann test signals  
In the absence of an acoustical measurement system, you can calibrate the settings of your subwoofer using Neumann test signals (see page 20).
  - C: Calibration using music signals and an 80 Hz test signal  
A calibration by means of music signals is also possible but should always be the last choice. In this case, play an 80 Hz test signal from your source equipment to calibrate the phase (see page 20).

-  For setting up the subwoofer via the Neumann.Control iPad® App follow the on-screen instructions.



### Calibration using the backplate controls and an acoustical measurement system

**i** The settings of the switch SUBWOOFER GAIN | OUTPUT LEVEL ⑪ and the potentiometer SUBWOOFER GAIN | INPUT GAIN ⑫ recommended in the following table are valid for the following settings of your Neumann loudspeaker: INPUT GAIN: “0 dB” and OUTPUT LEVEL: “100 dB SPL at 1 m for 0 dBu”. For information on how to set your Neumann loudspeaker, please refer to its operating manual. If the mentioned values cannot be set on your loudspeaker, adjust the subwoofer accordingly.

#### Calibrating the frequency response

The frequency response of a subwoofer depends on its position in the room and on the room geometry. The same subwoofer installed in different positions in the same room may require different acoustical control settings.

- Adjust the frequency response of the subwoofer at your listening position. To do so, proceed as follows:
- Make sure that the switch SUBWOOFER GAIN | OUTPUT LEVEL ⑪ is set to “100 dB SPL at 1 m for 0 dBu”.
- First, set the potentiometers SUBWOOFER GAIN | INPUT GAIN ⑫ and LOW CUT ⑤ to the following settings. These settings can be used as a starting point for further adjustment:

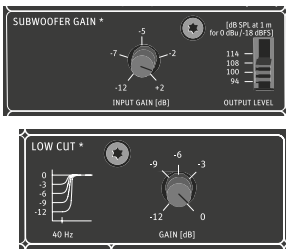

Subwoofer position	Setting of potentiometer SUBWOOFER GAIN   INPUT GAIN ⑫	Setting of potentiometer LOW CUT ⑤
In a corner	-8 dB	0 dB
Next to or flush mounted in an acoustically solid wall (e.g. brick, concrete)	-4 dB	0 dB
Next to or flush mounted in an acoustically soft wall (e.g. gypsum)	-2 dB	0 dB
Free standing in an untreated room	-2 dB	0 dB
Free standing in a well-treated room	0 dB	0 dB

- Check the frequency response at the listening position using your acoustical measurement system:
  - In the case of excessive very low frequency levels at the listening position, turn the potentiometer LOW CUT ⑤ to the left. This reduces the output level of the subwoofer towards lower frequencies.

#### Calibrating the subwoofer level

- Measure the subwoofer’s sound pressure level at the listening position.
- Adjust the sound pressure level of the subwoofer so that the level of the frequency response of the subwoofer below 80 Hz corresponds to the level of the frequency response of the loudspeakers above 80 Hz.
  - To do so, use the potentiometer SUBWOOFER GAIN | INPUT GAIN ⑫ and the switch SUBWOOFER GAIN | OUTPUT LEVEL ⑪. Make sure that the input signal is not too high.

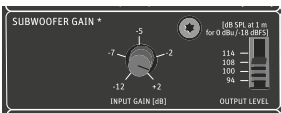

#### Calibrating the phase

- Set the phase using the left switch SUBWOOFER PHASE ⑭. Values from -180° to -315° can be obtained by setting the right switch SUBWOOFER PHASE ⑬ to “-180°” and by adding the set value of the left switch SUBWOOFER PHASE ⑭.
 

**Example:** To obtain a phase shift of -270°, set the right switch SUBWOOFER PHASE ⑬ to “-180°” and the left switch SUBWOOFER PHASE ⑭ to “-90°”.
- Set the left switch SUBWOOFER PHASE ⑭ in combination with the right switch SUBWOOFER PHASE ⑬ to values of 0°, -45°, -90°, -135°, -180°, -225°, -270°, and -315°, until you have found the setting that gives the lowest sound pressure level at the listening position at the cut-off frequency of 80 Hz (180° phase shift between subwoofer and loudspeaker, maximum level cancellation).

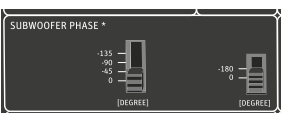



- ▶ Set the right switch SUBWOOFER PHASE ⑬ to the opposite position. The phase shift between loudspeaker and subwoofer is now 0°. Check your subwoofer’s sound pressure level again and, if necessary, readjust it so that it corresponds to the sound pressure level of the loudspeakers.

Your system is now completely acoustically calibrated.

- ▶ Note that any change of the low cut influences the crossover phase. Therefore, the phase and the level need to be recalibrated after changing the low cut EQ setting.

### Calibration using the backplate controls and Neumann test signals

- ▶ Download the Neumann test signals and the instructions for use (PDF file, in English) from the KH 750 DSP product page at [www.neumann.com](http://www.neumann.com).
- ▶ Follow the steps described there.

### Calibration using the backplate controls, music signals and an 80 Hz test signal

- ▶ Adjust the settings for the sound pressure level and the frequency response as described above.
- ▶ Calibrate the acoustical phase using an 80 Hz test signal. Check the settings of the sound pressure level and frequency response by means of music signals you are familiar with.
  - Connect the left front loudspeaker to the socket OUTPUT | LEFT ⑧.
  - Set the switch BASS MANAGEMENT ⑮ to “ACTIVE”.
  - Play an 80 Hz test tone from your source into the audio input INPUT | LEFT ⑨ so that the subwoofer and left loudspeaker are playing the tone.
  - Set the left switch SUBWOOFER PHASE ⑭ in combination with the right switch SUBWOOFER PHASE ⑬ to values of 0°, -45°, -90°, -135°, -180°, -225°, -270°, and -315°, until you have found the setting that gives the lowest sound pressure level at the listening position at the cut-off frequency of 80 Hz (180° phase shift between subwoofer and loudspeaker, maximum level cancelation).
  - Switch off the test signal at the source.
  - Set the right switch SUBWOOFER PHASE ⑬ to the opposite position.  
The phase shift between loudspeaker and subwoofer is now 0°.
- ▶ Check the settings of the sound pressure level and frequency response by means of music signals. Listen for a smooth extension of the frequency response of the main loudspeakers down to 20 Hz.

To to this, proceed as follows:

- ▶ Listen to music containing content down to 20 Hz. Activate and disable the bass management by repeatedly moving the switch BASS MANAGEMENT ⑮ between the two positions. There should be no increase or decrease in level between the lower cut off frequency of the loudspeaker and 80 Hz.

## Compensating for larger time of flight (TOF) differences

If the subwoofer is placed at a distance > 2 m (6'6") behind the loudspeakers with reference to the listening position, the subwoofer back panel phase controls will not suffice. In this case use the Neumann.Control iPad® App to access the built-in delay functionality.

## Using the bass management

- ▶ For a two-channel stereo system set the switch CHANNEL B INPUT MODE ⑳ to “STEREO/RIGHT”.
- ▶ Set the switch BASS MANAGEMENT ⑮ to “ACTIVE”.

The bass management is activated. This inserts a 4<sup>th</sup> order 80 Hz high pass filter into the signal path of the audio outputs OUTPUT | LEFT and RIGHT ⑧ and routes all audio signals below 80 Hz to the subwoofer. The LED BASS MANAGEMENT ⑮ lights up green.

If you deactivate the bass management, the audio signal of the audio outputs OUTPUT | LEFT and RIGHT ⑧ is only reproduced by the loudspeakers. Use this function to prevent the low frequency signal components of the main channels being reproduced by the subwoofer.

- ▶ Set the switch BASS MANAGEMENT ⑮ to “DISABLED”.

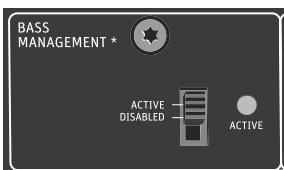
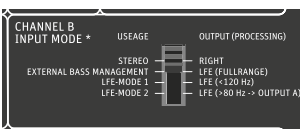
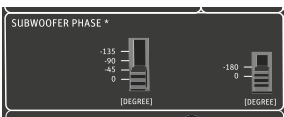
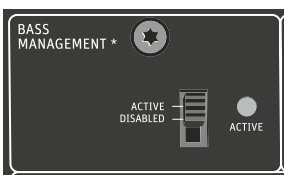



## Remote-controlling the bass management

It is possible to activate and deactivate the bass management filters remotely using Neumann.Control. This allows one to listen to the source as if there is no subwoofer connected in the system because the loudspeakers play full range with no filtering when the bass management is disabled.

## Setting the replay level of the subwoofer

**CHANNEL B INPUT MODE:** This mode should be used when the signal has not been encoded already. Do not use this mode when playing back DVDs, Blu-ray disks or if there is a bass manager before the subwoofer. The LFE channel should be replayed at a level 10 dB higher than the main channels. The level can be set in the monitoring matrix (console or external), or by setting an appropriate output level on the subwoofer.

LFE-MODE 1  
LFE-MODE 2

- ▶ Connect the LFE channel to the socket INPUT | B ⑨ of the KH 750 DSP.
- ▶ Set the switch CHANNEL B INPUT MODE ⑳ to “LFE MODE-1 or LFE MODE-2”.
- ▶ Calibrate the frequency response of the subwoofer to be flat.
- ▶ Measure the SPL of one of the main channels using pink noise and a sound level meter set to “C-weighted” and “Slow”.
- ▶ Measure the SPL of the LFE channel using pink noise and a sound level meter set to “C-weighted” and “Slow”.
- ▶ Adjust the level so it is 4 dB higher than the main channel. This corresponds to 10 dB more (unweighted) level.

**Note:** As the level of the subwoofer affects both channels, do not connect a center channel to the subwoofer when trying to add 10 dB to the LFE channel using the subwoofer level controls.

**CHANNEL B INPUT MODE:** The EXTERNAL BASS MANAGEMENT routing mode is used when there is a bass manager before the KH 750 DSP subwoofer, e. g. an AV amplifier with activated bass management and loudspeakers set to “small”. It should also be used when a the LFE output of a DVD or Blu-ray player is connected directly to the subwoofer (i.e. after the program material has been encoded). This mode avoids double filtering of the bass managed signal but still allows the subwoofer’s frequency response to be calibrated.

EXTERNAL BASS MANAGEMENT

- ▶ In the source, set the bass management system to “On”.  
This is typically achieved by setting the loudspeaker size to “Small”.
- ▶ In the source, switch the subwoofer output to “On”.
- ▶ In the source, choose a crossover frequency of 80 Hz.
- ▶ In the source, select the crossover slope to be 24 dB/oct., if possible.
- ▶ Connect the “Sub” channel to the socket INPUT | B ⑨ of the KH 750 DSP.
- ▶ Set the switch CHANNEL B INPUT MODE ⑳ to EXTERNAL BASS MANAGEMENT.
- ▶ Calibrate the frequency response of the subwoofer to be flat.
- ▶ Set the level so it has the same level as the loudspeakers.

**CHANNEL B INPUT MODE:** The LFE (FULLRANGE) routing mode is used when just the LFE signal of the source (DVD-player, Blu-ray player or AV-amplifier) should be replayed by the subwoofer (i.e. after the program material has been encoded). This mode avoids double filtering of the bass managed signal but still allows the subwoofer’s frequency response to be calibrated.

LFE (FULLRANGE)  
EXTERNAL BASS MANAGEMENT

- ▶ In the source, set the LFE channel to “Sub out”.  
This is typically achieved by setting the loudspeaker size to “Large” and “Subwoofer present”.
- ▶ In the source, switch the subwoofer output to “On”.
- ▶ Connect the “Sub” channel to the socket INPUT | B ⑨ of the KH 750 DSP.
- ▶ Set the switch CHANNEL B INPUT MODE ⑳ to EXTERNAL BASS MANAGEMENT.
- ▶ Calibrate the frequency response of the subwoofer to be flat.
- ▶ Set the level so it has the same level as the loudspeakers.



## Activating ground lift



If there is a humming or buzzing noise coming from the subwoofer, first search for the cause of the noise:

- ▶ Disconnect all input and output signal cables from the subwoofer.

If the noise goes away, it is probably coming from the audio source or source cabling. It might be possible to eliminate the noise by disconnecting the ground from the input signals (activating ground lift).

To activate ground lift:

- ▶ Reconnect the signal cables and set the switch INPUT GROUND LIFT ⑥ to “LIFTED”. This internally disconnects pin 1 of all XLR input sockets from the subwoofer electronics’ chassis ground (see table on page 10).

**i** For safety reasons, the electronics chassis ground is always connected to the mains power earth pin. Never disconnect the earth pin of the mains cable from ground. Even when ground lift is activated, the pin 1 of all audio inputs remain electronically connected to each other.

## Cleaning and maintaining the subwoofer

### CAUTION

Damage to the product caused by liquids!

Liquids entering the product can cause a short-circuit in the electronics and damage or even destroy the product.

- ▶ Keep all liquids away from the product.
- ▶ Before cleaning, disconnect the product from the mains power supply (see page 15).
- ▶ Use a soft, dry, and lint-free cloth to clean the product.



## Troubleshooting

Problem	Cause	Solution
There is hum or buzz coming from the KH 750 DSP when an analog audio cable is connected.	A cable is defective, the cabling is bad, there is ground loop in the installation or the level of the audio source is too low.	Check all cabling to eliminate the cause of the problem, do not lay signal cables parallel to mains cables, use balanced cables, use the ground lift switch (see page 22) or send higher signal levels from your source and reduce the level on your subwoofer and your loudspeakers.
There is a sudden reduction of the subwoofer's output level, the POWER ON LED ⑱ changes from green to red, the output level is reduced.	The temperature of the power amplifier is too high.	Ensure sufficient ventilation of the subwoofer and/or reduce the input signal level, or add extra subwoofers to increase LF headroom. When the temperature has dropped again, the POWER ON LED ⑱ lights up green and the output level reduction is canceled.
The POWER ON LED ⑱ lights up red in time with low-frequency input signals.	The signal level is too high, the protection system is active.	Reduce the signal level.
The logo does not light up	There is no LED behind the logo	This normal. The logo does not light up.
The back panel LEDs are off, no sound is heard from the KH 750 DSP.	The KH 750 DSP main fuse has blown.	Have the product checked by an authorized Neumann service partner.
	The KH 750 DSP is in standby	Wake up the KH 750 DSP by playing some audio into it.
The subwoofer sounds very "thin" in the bass. The low frequency response is very low.	Incorrect wiring in the analog audio cable.	Check the cabling, especially if unbalanced cabling has been used - see the cable wiring diagram on page 9.
No signal is coming out of the subwoofer and the connected loudspeakers.	Both analog and digital signals are connected.	If analog and digital sources are connected simultaneously to the subwoofer the digital source has priority. As soon as a digital clock signal is connected to the digital input, this input is chosen by default even if there is no audio signal present. Remove the digital connection if analog signal should be replayed.
No signal is coming out of digitally connected loudspeakers.	The KH 750 DSP currently does not support the digital outputs.	Connect the loudspeakers via the analog outputs instead.

For further information, please refer to the "Questions & Answers" section at [www.neumann.com](http://www.neumann.com).



## Specifications

For a complete list of the product specifications please refer to the product page of the KH 750 DSP at [www.neumann.com](http://www.neumann.com).

Product properties	
Mains voltage	100 to 240 V ~, 50/60 Hz
Power consumption (idle / standby)	18 W / 0.3 W
Power consumption (full output AC)	410 W
Dimensions (H x W x D)	383 x 330 x 383 mm (15 1/8" x 13" x 15 1/8")
External volume	48.4 l
Weight	19.5 kg (43 lbs)
Driver	1 x 265 mm (1 x 10")
Cabinet surface finish, color	painting wood (MDF), metallic anthracite (RAL 7021), painted back panel (RAL 9005)
Driver protection	metal grille (RAL 9005)
Temperature	
Operation and storage, unpacked	+10 °C to +40 °C (+50 °F to +104 °F)
Transport and storage, packed in original packaging	-25 °C to +70 °C (-13 °F to +158 °F)
Relative humidity	
Operation and storage, unpacked	max. 75 % (non-condensing)
Transport and storage, packed in original packaging	max. 90 % (non-condensing)

## Pin assignment of the XLR socket

1	Audio ground	
2	Signal +	
3	Signal -	

## Acoustical measurements and block diagram

Additional technical information such as acoustical measurements and a block diagram of the KH 750 DSP can be found on the product page at [www.neumann.com](http://www.neumann.com).

## Trademarks

Neumann® is a registered trademark of Georg Neumann GmbH. The following are trademarks of Georg Neumann GmbH:

- Plane Wave Bass Array™ and PWBA™
- Neumann.Control™

iPad® is a trademark of Apple Inc., registered in the U.S. and other countries.

Other company, product, or service names mentioned in this operating manual may be the trademarks, service marks, or registered trademarks of their respective owners.





## Technical information & glossary

**Absolute level** In Europe, the absolute level of 0 dBu is –18 dBFS (EBU standard R68). In the US, +4 dBu is –20 dBFS (SMPTE standard RP155). These dBu values should lead to the following sound pressure levels:

Application	Sound pressure level
Film	85 dB(C)
Broadcast	79 dB(C) (reference level)
Music	No defined reference levels

Near field loudspeakers can be as close as 1 m from the listening position, whereas loudspeakers in a Dolby certified movie mixing room should be at least 5 m from the listening position.

In the examples below, it is assumed that the listener is inside the room radius and thus the sound field decays according to  $20 \log_{10}(r)$ , however this may not always be the case.

Absolute voltage level of input signal	0 dBu (0.775 V)	+4 dBu (1.23 V)
Setting SUBWOOFER GAIN   INPUT GAIN ⑫	–1 dB	–5 dB
Setting SUBWOOFER GAIN   OUTPUT LEVEL ⑪	100	100
Listening distance [m] (dB change)	5 m (–14 dB)	5 m (–14 dB)
Measured output level in dB SPL at 1 m	85 dB SPL	85 dB SPL
Maximum input signal before activation of the protection system	17 dBu	17 dBu

Absolute acoustic level calibration for signal channels is generally achieved using a sound level meter set to “C-weighted” and “Slow”. Play a broadband pink noise test signal set to –18 dBFS (Europe) or –20 dBFS (USA) on the console meters and measure the sound pressure level at the listening position. Then adjust each channel’s source level, not the loudspeakers and subwoofer(s) so that the above stated sound pressure levels are achieved.

**Acoustical axis** The acoustical axis is a line perpendicular to the subwoofer’s front panel along which the microphone was placed when tuning the subwoofer’s crossover during design. The acoustical axis is located at the midpoint of the KH 750 DSP’s bass driver. Note that the subwoofer emits very low frequencies which are emitted omnidirectionally. That is why the orientation of the subwoofer cabinet in the room does not matter.

**Acoustical controls** The backpanel acoustical controls are low-order DSP filters designed to compensate for some of the acoustical issues commonly found in listening environments. The acoustical controls’ settings will depend on the subwoofer’s location and will probably be different for the same subwoofer type positioned in different locations in the same room. When calibrating subwoofers there are three areas requiring attention: in-room response, level relative to main loudspeakers, and phase relative to main loudspeakers.



**Acoustical output level**

Depending on the setting of the potentiometer SUBWOOFER GAIN | INPUT GAIN ⑫ and the switch SUBWOOFER GAIN | OUTPUT LEVEL ⑪ — and referred to an input signal level of 0 dBu — the following acoustical output levels can be obtained:

Setting of potentiometer SUBWOOFER GAIN   INPUT GAIN ⑫	Acoustic output level [dB SPL] of the subwoofer at 1 m when input signal level is 0 dBu			
	Setting of switch SUBWOOFER GAIN   OUTPUT LEVEL ⑪			
	94 dB	100 dB	108 dB	114 dB
-12 dB	82 dB SPL	88 dB SPL	96 dB SPL	102 dB SPL
-10 dB	84 dB SPL	90 dB SPL	98 dB SPL	104 dB SPL
-8 dB	86 dB SPL	92 dB SPL	100 dB SPL	106 dB SPL
-6 dB	88 dB SPL	94 dB SPL	102 dB SPL	108 dB SPL
-4 dB	90 dB SPL	96 dB SPL	104 dB SPL	110 dB SPL
-2 dB	92 dB SPL	98 dB SPL	106 dB SPL	112 dB SPL
0 dB	94 dB SPL	100 dB SPL	108 dB SPL	114 dB SPL
+2 dB	96 dB SPL	102 dB SPL	110 dB SPL	116 dB SPL

The default setting is SUBWOOFER GAIN | INPUT GAIN ⑫ = “0 dB” and SUBWOOFER GAIN | OUTPUT LEVEL ⑪ = “100 dB SPL at 1 m”, which corresponds to a sound pressure level of 100 dB SPL measured at a distance of 1 m in free field conditions, when the input signal has a level of 0 dBu.

Using the potentiometer SUBWOOFER GAIN | INPUT GAIN ⑫ and the switch SUBWOOFER GAIN | OUTPUT LEVEL ⑪, you can compensate for level differences due to acoustical loading (see page 8) and due to different distances of the subwoofers and loudspeakers from the listening position.

Examples of how to calculate sound pressure levels as a function of the input signal levels and input and output levels of the KH 750 DSP:



Absolute voltage level of input signal	0 dBu (0.775 V)	+4 dBu (1.23 V)	+6 dBu (1.55 V)	+16 dBu (4.89 V)
Setting SUBWOOFER GAIN   INPUT GAIN ⑫	0	0	0	0
Setting SUBWOOFER GAIN   OUTPUT LEVEL ⑪	100	100	100	100
Measured output level in dB SPL at 1 m	100	104	106	116

**Acoustical response**

Neumann subwoofers are designed to have a flat pass band magnitude response in anechoic conditions when all the acoustical controls are set to 0 dB. When a subwoofer is installed into a listening environment the response changes and thus should be corrected back to a flat response. It is therefore expected that the acoustical controls will need adjustment to improve the in-situ response of the subwoofer. The acoustical controls’ settings depend on the subwoofer’s location and the dimensions and behaviour of the room and will probably be different for the same subwoofer type installed in different locations in the same room. Moving the cabinet small distances, 50 cm (20”), can dramatically change the response therefore resulting in different acoustical control settings.

Graphs of acoustical measurements conducted in anechoic conditions at a distance 1 m can be found on the corresponding product pages at [www.neumann.com](http://www.neumann.com).



<b>Signal routing</b>	<p>For both analog and digital signals, the KH 750 DSP has two input and two output channels: LEFT / A and RIGHT / B. After the electronically balanced or digital input stages, there are two 4th order 80 Hz high pass filters for the main channels followed by two electronically balanced and digital output stages. The signal connected to the left input is always routed to the subwoofer via a 4th order 80 Hz low pass filter and to the left output via an 80 Hz 4th order high pass filter. This is the same for the right input when the input mode is set to STEREO/RIGHT.</p> <p>All outputs have protection circuits to avoid power on/off noises: the outputs switch on after a short delay when mains power is applied and mute instantaneously when mains power is removed.</p> <p>If you select the corresponding mode, there is also 120 Hz low pass filtering for an LFE channel, a full range monitoring mode for routing the LFE channel content above 80 Hz to the A output, or a wide input if you have an external bass manager (more details can be found on page Seite 20). Additionally, you can operate several subwoofers using Y cables.</p>
<b>Crossover</b>	<p>Using 4<sup>th</sup> order filters, the crossover divides the input signal of each channel into two bands for reproduction by the subwoofer or the main loudspeakers. The crossover frequency is 80 Hz for the main channels and can be bypassed when required. This default frequency was chosen to balance the conflicting requirements of having a high crossover frequency to relieve the main loudspeakers of their low frequency duties thereby reducing distortion, and of the need to have a low crossover frequency to minimize the chances of localizing the subwoofer thereby giving greater flexibility when placing the subwoofer in the room. In addition, by choosing 80 Hz, there is a compatibility with the replay conditions commonly found in consumer products. However, there are sometimes good reasons to use a different crossover frequency so it can be changed using Neumann.Control.</p>
<b>Driver</b>	<p>Long throw, efficient, low distortion driver ensures a clean sound quality even at high replay levels. The driver is loaded by the internal volume of the cabinet.</p>
<b>LFE channel</b>	<p>“Low Frequency Effects” (Dolby) or “Low Frequency Enhancement” (dts). The LFE channel has a limited bandwidth. Because of the limited frequency range of the LFE channel, it is referred to as “.1” when describing, for example, a 5.1 system. The designation “LFE channel” always refers to the source and not to the loudspeakers.</p>
<b>Power amplifier</b>	<p>The high efficiency power amplifier of the KH 750 DSP minimizes power dissipation and is run in bridged mode to minimize distortion.</p>
<b>Protection system</b>	<p>An extensive protection system prevents damage to the subwoofer if high signal levels are applied to the input for a long time (the higher the signal the earlier the protection system is activated). The POWER ON LED  changes from green to red when the protection system is active. In this case, reduce the input signal level. If this happens regularly, use a larger subwoofer with a higher SPL output or add more subwoofers to the system to increase the LF headroom.</p> <p>The protection system consists of thermal and peak limiters for the amplifier and thermal modeling of the driver. The protection system is not a compressor, it is designed to protect the subwoofer from damage. The protection system cannot protect against sustained abuse of the subwoofer system, i.e. playing the subwoofer for long periods of time with the POWER ON LED  lighted up red. Please avoid consistent abuse of the subwoofer to not affect the long service life of the product.</p>