

Product Specifications

SM57 Cardioid Dynamic Microphone

Overview

An industry-standard, highly versatile cardioid dynamic microphone that can be found onstage and in studios around the world. The ideal choice for sound reinforcement and recording applications, the legendary SM57 is tuned for clean reproduction of amplified and acoustic instruments, targeting the main sound source while minimizing background noise.

Features

- Frequency response tailored for drums, guitars, and vocals
- Uniform cardioid pickup pattern isolates the main sound source while reducing background noise
- Pneumatic shock-mount system cuts down handling noise
- Extremely durable under the heaviest use
- Supplied break-resistant swivel adapter that rotates 180°
- Legendary Shure quality, ruggedness, and reliability

Available Models

SM57-LC	Includes Stand Adapter and Zippered Pouch
SM57-LCE	Includes 5/8-inch to 3/8-inch thread adapter for mounting on European stands, Swivel Adapter and a Zippered Pouch

Specifications

Type	Dynamic
Frequency Response	40 to 15,000 Hz
Polar Pattern	Cardioid
Sensitivity (at 1,000 Hz Open Circuit Voltage)	Open Circuit Voltage: -56.0 dBV/Pa* (1.6 mV) *(1 Pa = 94 dB SPL)
Impedance	Rated impedance is 150Ω (310Ω actual) for connection to microphone inputs rated low impedance.
Polarity	Positive pressure on diaphragm produces positive voltage on pin 2 with respect to pin 3.
Case	Dark gray, enamel-painted, die-cast steel with a polycarbonate grille and a stainless steel screen.
Connector	Three-pin professional audio connector (male XLR type)
Net Weight	284 grams (10 oz)
Dimensions	157 mm (6-3/16 in.) L x 32 mm (1-1/4 in.) W at the widest point



SM57

Optional Accessories and Replacement Parts

A2WS	Locking Windscreen	A55M	Isolation Mount	C25F	7.6 m Cable (25 ft)
A25D	Microphone Clip	A26M	Dual Mount	RK143G	Screen and Grille Assembly
R57	Cartridge	S37A, S39A	Desk Stand		

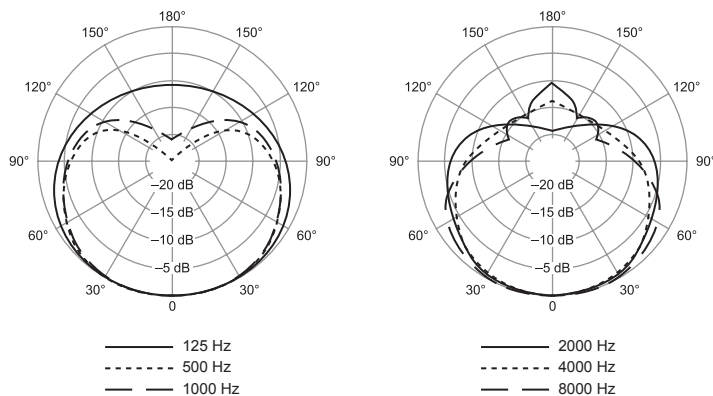

Polar Pattern

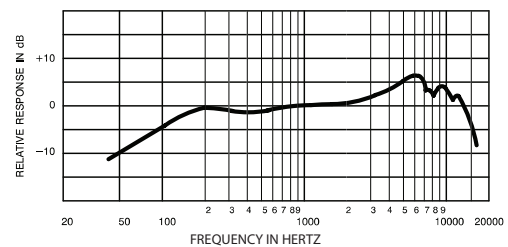

Frequency Response

