

BOSS

SD-1 **SUPER** **Over Drive** **INSTRUCTIONS**



Please read these instructions carefully for proper operating procedures for the BOSS SD-1.

The BOSS Super Over Drive SD-1 has been designed to exactly replicate the sound of an overdriven tube amplifier when used in any amplification setup. Unlike conventional distortion devices, the SD-1 is highly touch-sensitive and will respond to the guitarist's most delicate playing techniques. The unit wide range of over drive effects allow the effect to be varied from very hard to very soft. A distinct advantage of the SD-1 is its ability to adapt to any guitar, producing the wide range of over drive effects without fundamentally altering the tonal characteristics of the guitar itself.

NAME AND FUNCTIONS

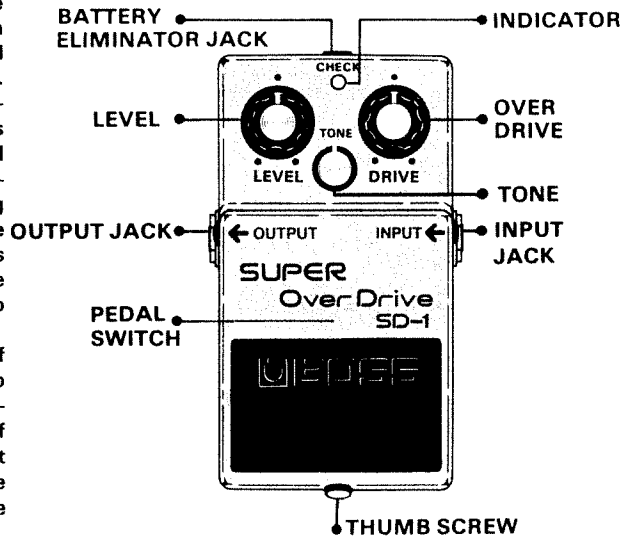

OVER DRIVE

The Over Drive regulates the amount of over drive effect, distortion harmonics and sustain from a very soft, subtle effect to one that is extremely hard.

TONE

The tone color of the over drive sound can be controlled by the Tone which varied the effect sound from crisp highs to soft lows.

LEVEL

The Level allows to control of SD-1's output loudness so that it can match or contrast with the straight signal.

INDICATOR

By the LED indicator you can see whether the unit is on or off, even in the darkest on-stage situation. This indicator also allows you to check the battery. When the time comes to replace the battery, the indicator fails to light or becomes dimmer.

INPUT JACK

The unit is powered-on by plug-in to the Input jack. Keep the plug out from the jack when not in use.

OUTPUT JACK

The SD-1's low impedance output to the amplifiers is offered to ensure low noise and hum.

BATTERY ELIMINATOR JACK

The BOSS AC Adaptor is connected to the Battery Eliminator jack when battery operation is not necessarily the most desirable situation.

PEDAL SWITCH

In our unique FET switching system there are no mechanical contacts in the signal system so it won't make an audible click, and it can't make a pop. The switching is done totally electronically and therefore, cleanly.

THUMB SCREW

The battery sits in a special compartment under the same footswitch plate that activates the silent switch. When the time comes to replace the battery, you don't even need tools.

*Do not remove off the screw from the unit.

BEFORE USING SD-1

•When operating SD-1 from AC line, use BOSS AC Adaptor for SD-1.

•Avoid using SD-1 in very dusty location or under high temperature or humidity conditions.

CONNECTING SD-1

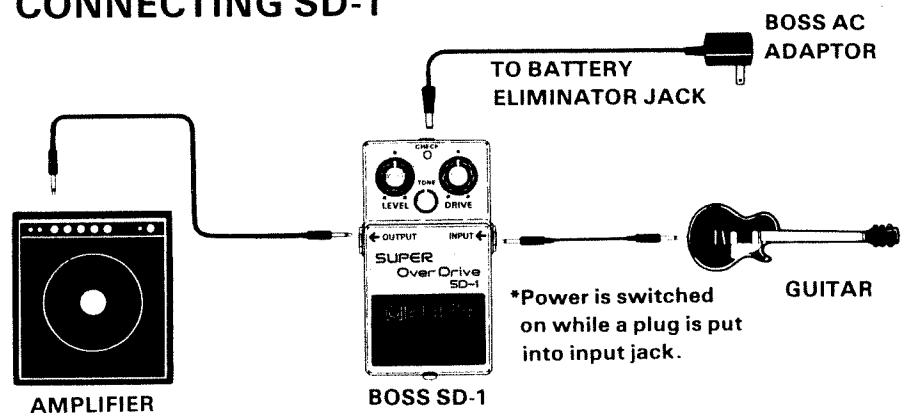

Unplug this unit when it is not to be used. Be sure to take off connecting plug from Input jack.

OPERATING SD-1

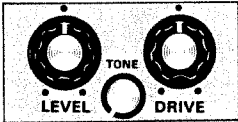
1  After connecting all cords required, set all knobs on the panel as illustrated.

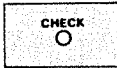
2  Depress the pedal switch. Check LED lights to indicate "EFFECT ON" and extinguishes to indicate "EFFECT OFF".
*This check LED is also used to check battery. If LED fails to light or becomes dim, the battery should be replaced.

3  Turn OVER DRIVE control to proper position.

4  While switching pedal ON and OFF, turn LEVEL knob to proper position so no volume difference between Normal and Effect modes is noticed.

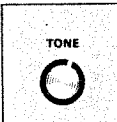
5  Turn TONE knob to proper position.

CAUTIONS FOR REPLACING AND HANDLING BATTERY

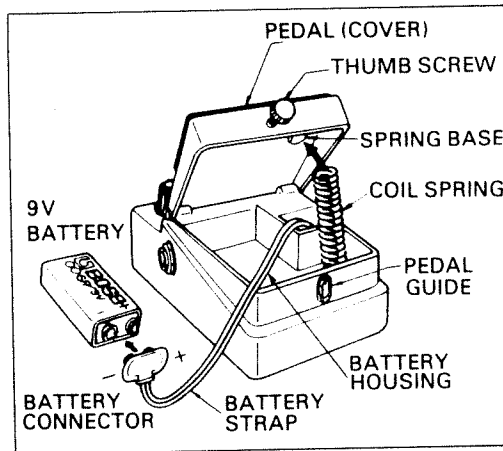

REPLACING BATTERY USE ONE 9-VOLT BATTERY.

- 1 Loosen the screw of pedal to open it and take out battery from its housing.
- 2 Replace the battery by a fresh one and put it into position.
- 3 Set coil spring onto the projection on the rear of the pedal and shut the cover (pedal). Finally, insert the screw into the pedal guide and tighten it. At this time, be careful not to catch the battery strap in the cover or coil

CAUTIONS

- When you don't use for a long period, remove the battery to prevent current leakage and leaking out of sticky substance.
- If battery voltage drops, effect becomes inferior or no sound is produced. To prevent that, replace the battery a little earlier.
- Be sure to keep the battery snapped by connector into the housing, when using AC adaptor, too.
- *Even if AC Adaptor cord comes out during performance, operations immediately changes to battery, causing no trouble in continued performance.
- Power is switched on while a plug is put into input jack. When you do not use, keep the plug off the jack.

AC ADAPTOR (OPTION)

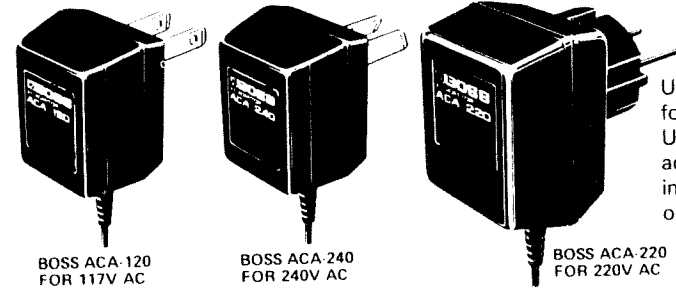

Use BOSS AC adaptor for AC operation. Use of different adaptors may cause improper operation or no sound.

SPECIFICATIONS

Power	Battery 9V (1) AC Adaptor
Current Draw	4mA at 9V
Control	OVER DRIVE, LEVEL, TONE
Others	Normal/Effect Changeover Switch (FET switching system), Battery Check Lamp (Also for confirmation of Normal/Effect changeover)
Jack	Input, Output, AC Adaptor
Input impedance	470 k Ω
Output load impedance	Over 10 k Ω
Dimensions	70(W) \times 55(H) \times 125(D) mm
Weight	400 g

***Specifications are subject to change without notice.**



Products of Roland

SD-1 OWNER'S MANUAL '82 Apr. E-3

 Roland®

17049760

UPC 17049760

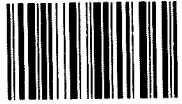

10981

 **BOSS**